



Perspex® Design Guide



Amphitheatre made using Perspex® Frost, Photograph: Pavan Consultants/Mitchell Plastics Pty Ltd

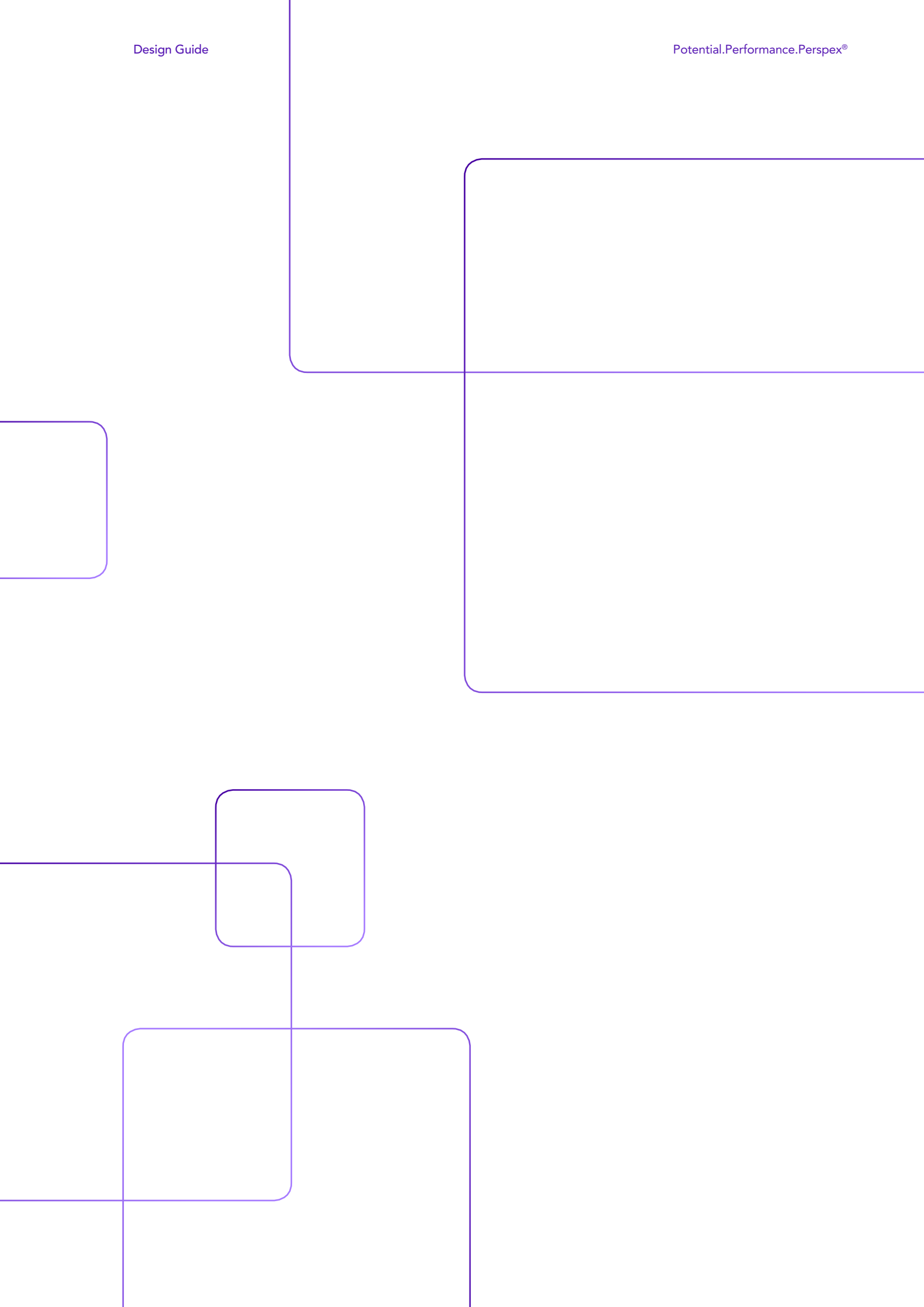

Table of Contents

Introduction	3	Part 2: Design & Applications	22
Outstanding Properties of Perspex®	3	2.0 Perspex® Products	22
Part 1: Fabrication	4	2.1 Perspex® Glazing	22
Engineering design data	4	2.2 General Glazing	23
Thermal and moisture expansion	4	2.2.1 Compatible Products	23
Masking protection	5	2.2.2 Recommended Thickness of Perspex® for Windows	23
Storage	5	2.2.3 Installation	24
Preparing for fabrication	5	2.2.3.1 Mounting Details	24
Cleaning	5	2.2.3.2 Thermal Expansion Clearance	24
Proprietary acrylic polishes	5	2.2.3.3 Rebate Depth	24
1.1 Machining	6	2.2.4 Sound Reduction Index	25
1.1.1 Cutting Tools	6	2.2.5 Heat Transfer Coefficient & Thermal Conductivity	25
1.1.2 Sawing	6	2.2.6 Perspex UV Absorbing & IR Transmitting Grades	26
1.1.3 Scribe – Breaking	7	2.3 Glazing Applications	27
1.1.4 Laser Cutting	7	2.3.1 Roofing	27
1.1.5 Laser Engraving	7	2.3.2 Balcony Guards	28
1.1.6 Drilling	8	2.3.3 Security Glazing	28
1.1.7 Screwing and Tapping	9	2.3.4 Boat Glazing	28
1.1.8 Turning	9	2.3.5 Vehicle Glazing	29
1.1.9 Spindle Moulding	9	2.3.6 Flooring	29
1.1.10 Routing	9	2.4 Lighting	30
1.1.11 Finishing	9	2.5 Visual Communications	30
1.1.11.1 Sanding	9	2.5.1 Illumination	30
1.1.11.2 Power Buffing	9	2.5.2 Luminance	31
1.1.11.3 Diamond Polishing	9	2.5.3 Light Transmission	31
1.1.11.4 Flame Polishing	9	2.5.4 Diffusion Factor	31
1.1.11.5 Hand Polishing	9	2.5.5 Light Source Spacing ratio	31
1.2 Thermoforming	10	2.6 Factors Affecting Perceived Colour	32
1.2.1 Pre-drying	10	2.6.1 Thickness Tolerance	32
1.2.2 Heating	10	2.6.2 Surface Finish	32
1.2.3 Shrinkage	12	Part 3: Technical And Performance Properties	33
1.2.4 Cooling	12	3.0 Weathering	33
1.2.5 Thermoforming of Colours	12	3.1 Light Transmission Properties Of Coloured Sheet	33
1.2.6 Methods of Thermoforming	13	3.1.1 Light Transmission Values of 3 mm Perspex® Colours	34
1.2.6.1 Single Curvature Thermoforming	14	3.1.1.1 Perspex® Opals (including Perspex® Spectrum LED)	34
1.2.6.2 Tubes	15	3.1.1.2 Perspex® Solid and Translucent Colours (including Spectrum LED)	34
1.2.6.3 Local Bending	16	3.1.1.3 Perspex® Transparent Colours and Tints	35
1.2.6.4 Vacuum Forming	16	3.1.1.4 Perspex® Neutrals for Glazing	35
1.2.6.5 Moulds	17	3.2 Food Contact	35
1.3 Cementing, Fixing and Sealing	18	3.3 Technical Data	36
1.3.1 Cementing	18	3.3.1 Physical and Mechanical Properties	36
1.3.1.1 Lamination/Face-to-Face Bonding	18	3.3.2 Reaction to Fire	36
1.3.1.2 Edge Bonding	18	3.3.3 Chemical Resistance	37
1.3.1.3 Bonding to other Substrates	18		
1.3.2 Fixing Methods	18		
1.3.3 Sealing	18		
1.4 Printing, Painting and Surface Decoration	19		
1.4.1 Screen Printing, Spray-painting and Hot-foil Stamping	19		
1.4.2 Self-adhesive vinyl films	19		
1.4.3 Stress in Acrylic Sheet	19		
1.5 Annealing	19		
1.6 Normalising	20		
1.7 Safety	21		
1.8 Recycling	21		

Introduction

Perspex® acrylic sheet is a most useful material in the workshop because it can be used to make precision engineering components for both domestic and industrial products. Typical applications include signs, glazing, safety screening, roof-lighting, furniture, lighting fittings and a great many industrial parts. Perspex® is manufactured in two forms; cast and extruded sheet.

Perspex® cast sheet is available in a wide range of thicknesses and colours, including blocks, colours and surface patterns.

Some differences exist between Perspex® cast and Perspex® XT (extruded) properties arising from their molecular structure and this can be reflected in their fabrication behaviour. These differences are highlighted where appropriate in the handbook. Otherwise, fabrication behaviour may be assumed to be very similar for both products.

Outstanding Properties of Perspex®

Exceptional light transmission with virtually no colour bias - even in thick blocks.

Clear Perspex® transmits 92% of all visible light. No other product offers better light transmission – not even glass!

Excellent resistance to outdoor weathering.

We offer a ten year weathering guarantee on the outdoor performance of standard Perspex® sheet. No significant change in visual appearance or physical performance will take place during ten years outdoors.

A high gloss, hard surface.

Perspex® is one of the hardest thermoplastics and remains aesthetically attractive for much longer than many other plastic sheet products.

High tensile strength and rigidity.

Perspex® is ideal for applications where surfaces that are resistant to bending or deformation are required.

Lightweight.

Perspex® is half the weight of an equivalent glass panel and is more easily transported, installed and supported.

Good resistance to impact.

Perspex® is internationally recognised as a safety glazing material meeting the requirements of ANSI Z.97 and BS 6262.

Easy to clean.

The high gloss surface of Perspex® makes it easy to clean, keeping maintenance costs to a minimum.

Easily thermoformable.

Perspex® is easy to thermoform with low cost tooling leading to cost effective production.

Excellent environmental credentials.

Perspex® an efficiently produced, non-toxic pure material with a long service life. Perspex® can also be recycled all the way back to the original raw material 'monomer' – regardless of colour or aesthetic effect.



Part 1: Fabrication

Engineering design data

The long-term mechanical performance of Perspex® will depend on temperature and applied stress and when designing engineering components these considerations must be taken into account. Table 1 gives details of the maximum long-term and short-term design stress levels derived from fracture mechanics studies that can be safely applied to engineering components made from Perspex® cast sheet. Please refer to the short-term physical properties in Technical Appendix, section 3.3.1.

Table 1 Design data for Perspex® cast acrylic sheet at 20°C

Property	Units	Short-Term/Intermittent (6 hours)	Long Term/Continuous (10 years)
Tensile strength (unexposed)	kgf/cm ²	170	88
	MPa	17	8.6
	lbf/in ²	2500	1250
Tensile strength (exposed)	kgf/cm ²	140	70
	MPa	14	7
	lbf/in ²	2000	1000
Modulus	kgf/cm ²	2.5 x 10 ⁴	1.3 x 10 ⁴
	GPa	2.5	1.2
	lbf/in ²	3.6 x 10 ⁵	1.8 x 10 ⁵
Poisson's ratio		0.39	0.40

Thermal and moisture expansion

Perspex®, in common with all acrylic materials, will expand or contract with temperature change and may be subject to water absorption over long periods of service. It is therefore important to consider these inherent characteristics when designing with Perspex® to create durable impactful and cost-effective signs.

Acrylic sheet may absorb up to 2% of water over long periods and this absorption can result in dimensional changes in the sign. The level of absorption and the dimensional change depends on the relative humidity of the atmosphere and the initial water content of the sheet. As a general rule, 100% relative humidity can result in a dimensional increase of 0.3% and due allowance should be made for any possible expansion to avoid distortions occurring in the sign.

Perspex® XT extruded acrylic sheet can exhibit slightly more dimensional change in humid environments due to the lower initial moisture content of extruded sheet.

The coefficient of linear thermal expansion of thermoplastic materials is greater than that of most other materials and therefore where significant variations in temperature are expected during the service use of the outdoor application, an allowance must be made for thermal movement of the material.

When Perspex® sheet is to be used for any outdoor applications adequate allowance must be made for thermal expansion and contraction during the design and construction of the sign. In Europe, external signs can be subjected to extremes of temperature from -20°C in winter to +30°C in summer, a temperature variation of 50°C. From many years practical experience it has been found that as a general rule and bearing in mind that darker colours will be more reactive to heat than lighter colours, an expansion allowance of 0.5%, or 5mm per metre run length, on both panel dimensions should be sufficient to accommodate any temperature and humidity variations.

It is equally important to bear in mind that when fixing Perspex® sign panels into frames the rebate depth of the framing must be sufficient not only to accept the expansion clearance but also an equivalent contraction allowance otherwise, panels could be blown out of their frames in gale force winds during the winter months.

Masking protection

The surfaces of Perspex® are covered with a masking film for protection during transport, storage and fabrication. A thermoformable masking can be applied on request, subject to minimum order quantities.

Storage

Perspex® sheet must be stored indoors, preferably in a cool, well ventilated, dry room maintained at a reasonably constant temperature. It is recommended to store sheets horizontally. It is strongly recommended not to stack pallets so as to create internal stresses and alter the flatness of the sheets. Perspex® can also be stored vertically in racks no more than 30cm in width to give adequate support and stability. It is recommended to avoid storage of the Perspex® sheet for more than 6 months.

Furthermore, failure to allow expansion allowances will result in warping of the sheet.

Preparing for fabrication

The masking film can frequently be left in place during fabrication work and all marking-out drawn on the film. The film must be removed before thermoforming operations.

Cleaning

Surfaces of items made from Perspex® should not generally require cleaning until after fabrication and before packaging. If however, any surface decoration process is planned such as vacuum metallization or screen printing it is advisable to wash the sheet surfaces to be decorated with clean, fresh water using a chamois leather or soft cloth. This has the advantage of removing all traces of static charge from the sheet after removal of the film which might otherwise attract dust. For all general purpose cleaning operations, Perspex® should be washed simply with clean cold water to which a little detergent has been added. The use of any solvents such as methylated spirits, turpentine, white spirit or proprietary window cleaning products is neither necessary nor recommended.

Chamois leather is suitable for cleaning, but cloths must never be used dry.

Proprietary acrylic polishes

Proprietary acrylic polishes are available to restore the surface finish of Perspex® glazing in the event of accidental scratches and these products are available from your local Perspex® supplier.



1.1 Machining

The machining characteristics of Perspex® are similar to those of soft brass or hard aluminium, but there are two important differences:-

1. Perspex® will soften if heated above 80°C. Considerable heat can be generated by machining, causing stress, so it is therefore very important that heat build-up is kept to a minimum. The use of coolants during machining is recommended to assist in lubrication, removing swarf and to maintain a cool stress-free machining temperature.
2. Perspex® is a brittle material. It is therefore important that only light machining cuts are taken and feed rates are kept slow. Various coolants can be used including water and water/air mists, soluble oils and compressed air. Soluble oils must be oil-in-water emulsions and must not contain solvents which may cause stress cracking.

When machining, drilling or cutting Perspex®, the heat build-up can generate stress in the final work piece which can induce "stress-cracking", a phenomenon common to many plastics materials when stressed. The risk of crazing can be reduced or eliminated by the simple process of heat annealing and it is strongly recommended that all machined or worked components made from Perspex® are annealed. Please see section 1.5 for full details of the annealing process.

1.1.1 Cutting Tools

To achieve a good finish on Perspex®, all cutting tools must be kept sharp. Most hand tools designed for use with wood and soft metals are suitable for use with Perspex® except laminate cutters, guillotines and blanking dies. If necessary, these tools can be used with Perspex® provided the sheet is heated to at least 50°C. Most power tools can be used and HSS tools bits are suitable to achieve a good cut finish.

For lengthy runs, tungsten carbide tipped blades and tool bits are recommended for long life. For accurate work, especially where a high degree of finish is required, diamond-tipped tools are particularly suitable for machining Perspex®.

1.1.2 Sawing

For small jobs, Perspex® may be cut with fine-toothed hand saws such as fret saws and hack saws. The work must be securely fixed and only light pressure applied. Powered saws with blades having alternative teeth bevelled, as for aluminium, are particularly recommended for sawing Perspex® as are band saws, jigsaws and fret saws. The recommended conditions for sawing Perspex® are given in Table 2.

Figure 1 gives details of the recommended type of TCT circular saw blade suitable for cutting Perspex® sheets.

Table 2 Conditions for sawing Perspex®

Saw Type	Optimum Blade Speed (approx)	Optimum Saw Pitch Sheet Thickness	Teeth/cm	Recommendation
Bandsaw	1500m/min	Up to 3mm 3-13mm Over 13mm	6-8 4-5 1.5-2	Keep saw guides as close together as possible to prevent blade twisting
Circular saw (carbide tipped)	3000m/min	All thicknesses	0.8-1.6	See Figure 1
Jigsaw fretsaw	Non critical	Up to 6mm	5-6	Allow blade to stop before withdrawing from saw cut

Fig. 1a

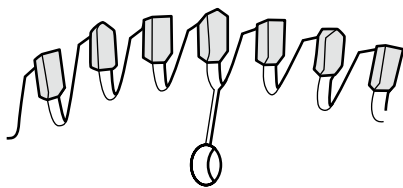

Typical diameter: 200 - 250mm
Width: 2 - 3mm

Fig. 1b

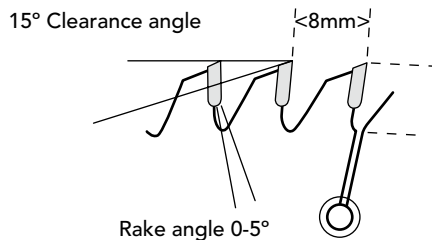
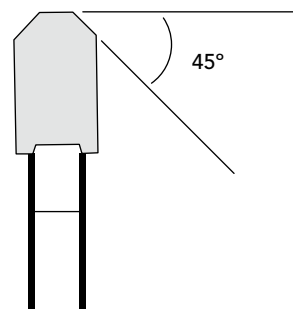

Fig. 1c



Bevelled tooth

Figure 1 A tungsten carbide tipped saw blade suitable for cutting Perspex®

1.1.3 Scribe – Breaking

Perspex® up to 4mm thick may be conveniently cut in a straight line by deeply scribing one surface several times with a sharp metal scriber, clamping the sheet with the scribed line uppermost and pressing sharply down over the edge of a bench. See Figures 2 and 2a for details of scribe-breaking.

Fig. 2

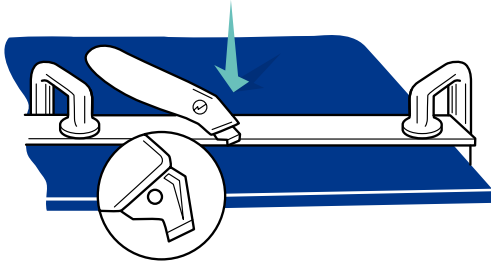

Figure 2 A Scribe-breaking Perspex® suitable for cutting Perspex®

Fig. 2a

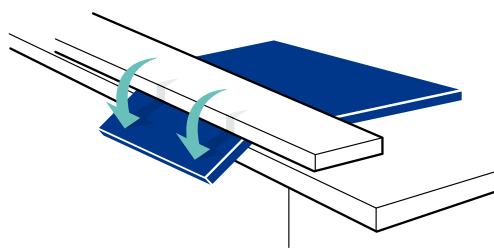

Figure 2a Breaking along the scribeline

1.1.4 Laser Cutting

Perspex® may be laser cut (see Figure 3) and very complex and intricate shapes may be cut out using this type of equipment. Thicknesses up to 25mm can be cut although some experimentation will be necessary to achieve the optimum quality of edge finish above 12mm. Some stress can be generated around the edge of laser cut Perspex® and it is important that the laser beam is accurately focussed. If cementing or surface decorating up to a laser cut edge it may be found necessary to carry out a short annealing cycle (see later) to reduce the risk of fine crazing along the edge. It may be found preferable to remove the top masking film to improve the edge polishing effect from the laser.

NB: When laser cutting Perspex®, as with all other materials, it is very important to provide adequate ventilation at the cutting head to remove any traces of unpleasant combustion vapour. Expert advice should be sought from the machine manufacturers if in any doubt. Before laser cutting Perspex®, please read the safety notes on flammability and combustion products on page 26.

1.1.5 Laser Engraving

Perspex® is easy to engrave using pantographs or CNC engraving machines. Laser engraving can also be carried out to give remarkable fine detail on Perspex®. The use of coolants is generally unnecessary for mechanical engraving other than the use of a compressed air jet directed on to the cutting head to remove swarf and cool the cutter. Filling is best carried out using one of the usual setting waxes. Paints can be used but it is most important to use those paints intended for use with acrylic sheet and known to be compatible. When intending to engrave Perspex® and fill with paint, especially for outdoor use, annealing of the engraved sections before filling is strongly recommended to prevent subsequent crazing.



1.1.6 Drilling

Standard woodworking twist drills can be used for all normal drilling work with Perspex®. It is advisable to re-grind twist drills to give a zero rake; Figure 3 demonstrates the preferred cutting angles

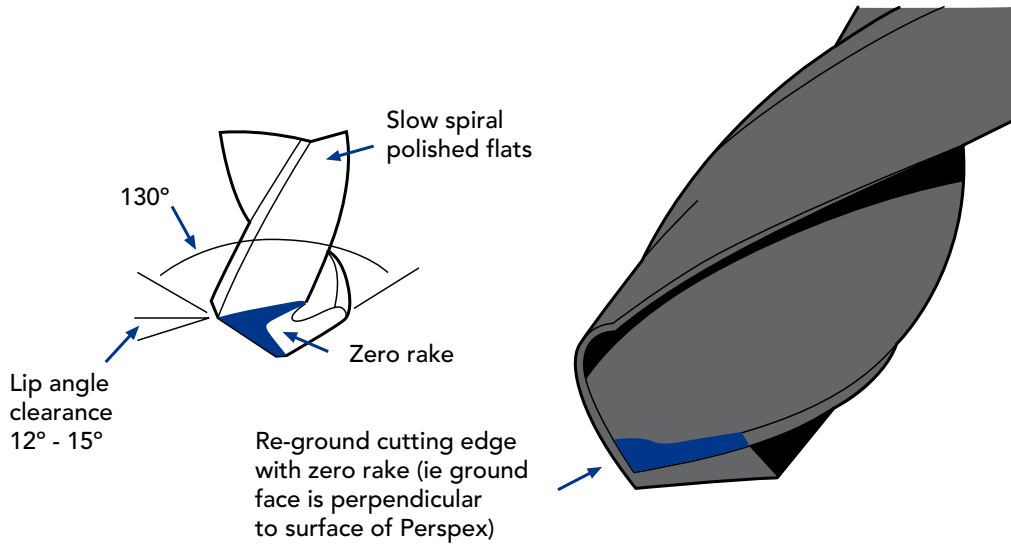

Figure 3 A standard drill (130°) with cutting edges re-ground for use with Perspex®

Wherever possible, the work should be supported by a back stop made from either scrap Perspex® or hardwood to prevent splintering the exit hole. Under no circumstances should a centre punch be used before drilling Perspex®. A small pilot hole should be drilled first to locate the drill.

Coolants are strongly recommended for any deep drilling into Perspex® and time must be allowed to remove swarf from the drill at regular intervals.

Hole saws may be used for larger holes greater than 12mm diameter but when drilling large holes in thin extruded sheet, especially if it is not possible to support the work, "cone-cut" drills have been found to be particularly suitable.

1.1.7 Screwing and Tapping

Standard taps and dies may be used for cutting screw threads in Perspex® but wherever possible, coarse threads are preferred as they are less liable to damage. Lubricants are essential, water or soluble oil being preferred. Threads must not be overstressed and it is not advisable to thread Perspex® if frequent dismantling is likely. In such conditions, threaded metal inserts are recommended.

1.1.8 Turning

Perspex® can be turned on conventional metalworking lathes but it is important to keep the work cool by the use of coolants and ensuring that feed rates are slow. Any overheating of the work is likely to lead to localised distortions and a loss of tolerance. Cracking may also occur sometime after.

Correct grinding of the lathe tool is necessary. HSS tool bits are preferred, ground to zero rake at the top and 15-20° front rake. The fine grain texture of HSS tools ensures a better finish than TCT tools but all cutting surfaces must be kept very sharp.

Cutting speeds of 90-150m/min are typical for turning Perspex® but for a first class finish, speeds of 15-30m/min are recommended.

Diamond fly-cutting is particularly recommended where a good polished finish is required after turning.

1.1.9 Spindle Moulding

A spindle moulder is a useful machine for the rapid machining of Perspex®. Cutters designed for woodworking are suitable, two-bladed cutters being preferred. Spindle moulding is carried out dry as swarf is easy to remove.

1.1.10 Routing

Routing is a common machining operation used on Perspex® today. Fixed head, moving head or portable standard woodworking routers are suitable for Perspex® using the same cutter speeds as for wood. Double edged cutters are preferred, ground and honed with a back clearance angle of about 12° or more.

Cutters	Spindle Speed
6 to 12mm diameter or less	ca 24000 RPM
>12	ca 18000 RPM

Routing is usually performed dry but provision must be made to clear all swarf from the work bench and keep the cutter cool. A compressed air jet directed at the work piece usually performs this task.

HSS cutters give better results than TCT cutters although their life will be shorter. Regular sharpening is therefore necessary.

1.1.11 Finishing

Machined surfaces of Perspex®, with the exception of laser cutting which many customers will leave as a finished edge, are usually matt unless diamond cutting tools are used. Machine marks are best removed by scraping with a sharp blade set at 90° or sanding and then the gloss finish restored by polishing.

1.1.11.1 Sanding

Bench mounted or portable sanders may be used - as may belt sanders - to remove machine marks or saw cut marks from the edge of Perspex®.

Sanding should be carried out dry and only very light pressure applied to prevent softening or melting of the surfaces.

After any sanding operation it will be necessary to anneal the work if cementing or surface decoration is intended.

1.1.11.2 Power buffing

Power buffing with rotating calico mops is the traditional polishing technique for Perspex®. Edges must first be scraped or sanded to remove all machine marks then a mild abrasive buffing soap may be applied. Moderate speeds and only very light pressure is needed otherwise overheating will occur.

1.1.11.3 Diamond polishing

Diamond polishing can be used for straight edges and gives excellent results without the rounded edges often produced by buffing. Diamond polishing produces very little stress in the surface.

1.1.11.4 Flame polishing

Flame polishing is ideal for polishing thin edges of Perspex®, because it is fast and effective. A good routed or scraped edge is essential for flame polishing. Specialised equipment is available otherwise a small blowtorch type gas-air flame can be used. The technique requires some practice to achieve the desired level of skill. Only the slightest impingement of the hottest part of the flame is required rapidly passing the jet across the work. Great care must be taken not to ignite the surface and it should be noted that flame polishing can produce highly stressed edges. Annealing of the work piece will be necessary if the flame polished edges are to be cemented or decorated.

Flame polishing can be difficult on certain heavily pigmented colours resulting in a matt finish or discolouration.

1.1.11.5 Hand polishing

Hand polishing is suitable for the restoration of the original gloss finish after minor surface scratching. Deep scratches should first be removed using 600 grade waterproof abrasive paper applied wet with a light circular motion. To avoid optical distortions, the abraded area should be much larger than the damaged surface to "feather" the edges. Final polishing of the matt abraded area can be carried out using proprietary acrylic polishes. Good quality metal polish intended for use on silver plate can be used provided the product has been tested and found to be compatible with Perspex®.

1.2 Thermoforming

General

To thermoform Perspex® correctly it must be heated uniformly and cell cast sheet requires slightly more heating than extruded sheet. The optimum heating time and temperature will depend on the thickness of the sheet, the type of mould being used and the degree of stretching required.

Fundamental differences exist between the thermoforming of cast and extruded sheet and it is important to understand what these differences are before any work is started in order to achieve the best results. For example, Perspex® Continuous Cast and extruded sheet have lower thermal softening temperatures than cast sheet, meaning that they soften more easily and can be stretched with very little force. For this reason they are more suitable for vacuum forming than Perspex® cell cast sheet. Extruded sheet if overheated will start to extend under its own weight if hung in a vertical heating oven and control of heating time and temperature are critical if oven heating is used.

The heating of extruded sheet on a horizontal oven shelf is not recommended because the hot sheet surface marks easily and can quickly stick to the shelf. Infra-red heated vacuum forming machines can overcome these difficulties and are the preferred option for thermoforming Perspex® extruded sheet.

Perspex® cast sheet is more suited to thermoforming by mechanical press-forming where greater force can be applied by clamping and pressing.

1.2.1 Pre-drying

Typically it is not necessary to pre-dry Perspex® cell cast acrylic sheet prior to thermoforming. This however is not necessarily the case for Perspex® Continuous Cast or extruded sheet, where pre-drying is generally recommended.

1.2.2 Heating

When Perspex® cast sheet is heated to 140-170°C it becomes flexible and rubber-like and can be formed into complex shapes by the application of force such as air pressure or mechanical press clamping. If held to that shape and cooled below 90°C it will retain the shape. If reheated, it will return to its original flat condition.

When Perspex® extruded sheet is heated to this temperature range it behaves in a similar manner to cast sheet except that it is easier to deform, requiring less force and will actually flow rather than stretch. Consequently, mouldings made from extruded sheet will not return to the flat condition on re-heating.

Figure 4 illustrates the effect of heating on both cast and extruded sheet and as a general rule, the preferred thermoforming temperature for cast sheet is 170°C and 155°C for extruded sheet.

When heating impact modified grades of Perspex® it will be noticed that the sheet becomes opaque at the shaping temperature. This is perfectly normal and the clarity will return when the shapings reach room temperature.

Cell Cast Sheet

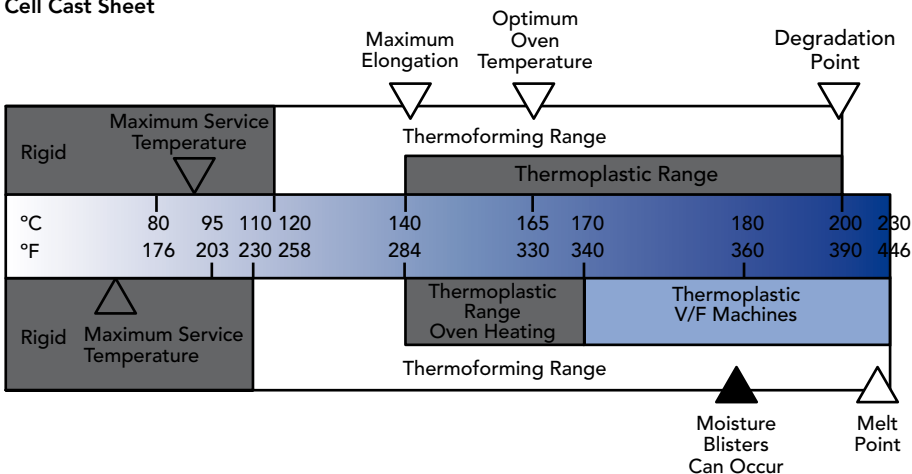

Figure 4 Heating Perspex® – transition stages

Except when local bending, the entire area of Perspex® sheet should be uniformly heated and for cast sheet the best equipment for this is an air circulating oven with accurate temperature control. Both clear and coloured sheets may be laid on clean horizontal shelves in the oven but when optical quality is paramount, sheets should be hung vertically to avoid any surface damage or contamination during heating. Suitable hanging clamps can be devised to suspend the sheets along their longest dimension. Vertical hanging is also the recommended method for heating extruded sheets in an air circulating oven.

Figure 5 gives a diagrammatic description of a typical air circulating oven suitable for heating Perspex® sheets.

As an alternative to air oven heating, certain infra-red heaters can be used to heat Perspex® sheet, e.g. quartz and ceramic elements, but since these can heat the Perspex® surfaces very quickly, heaters and heated platens must be designed to give uniform heating under carefully controlled conditions to avoid overheating and degrading the sheet.

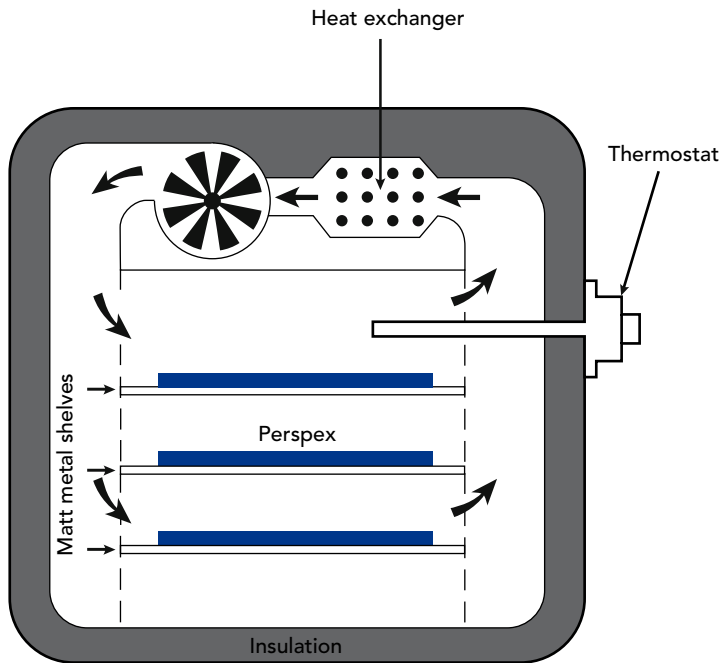

Figure 5 Air circulating oven

Ceramic or Quartz Elements
 Operating Temperature: 400 - 1000°C (752 - 1832°F)

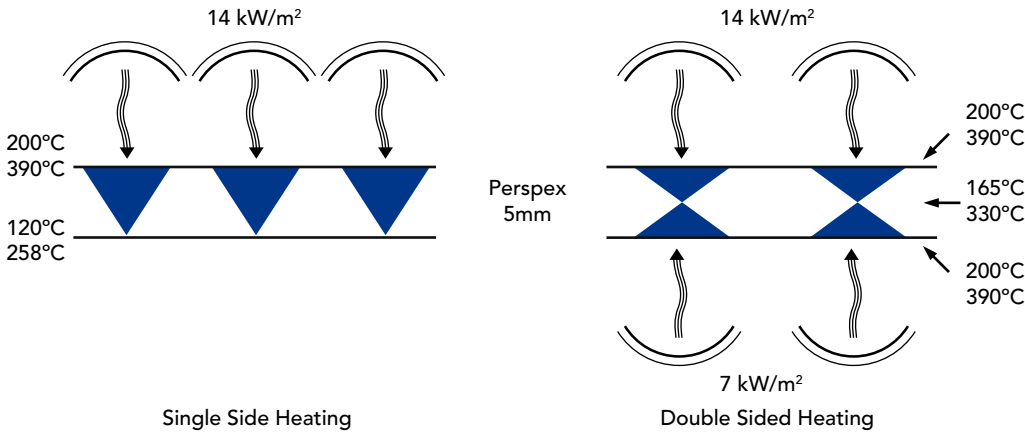

Figure 6 gives details of the heating of Perspex® using typical infra-red heaters.

When using infra-red heaters the sheet should be heated simultaneously on both sides, i.e. with the use of double-sided heater platens.

SAFETY NOTE

Infra-red heaters as used on vacuum forming machines can raise the temperature of the sheet very quickly and overheating is possible. If the surface temperature of Perspex® exceeds 200°C, degradation will occur leading to decomposition and the evolution of flammable decomposition gases. Initial indications of this for cast sheet are the appearance of blisters on the surface followed by a crackling sound as the sheet begins to decompose.

If blisters or bubbles appear in extruded sheet without any indication of decomposition it is more likely that this is due to absorbed moisture, requiring an overnight drying cycle at 75-85°C.

1.2.3 Shrinkage

The production processes for cast and extruded Perspex® sheets differ fundamentally and both materials will exhibit some shrinkage when heated to thermoforming temperature. When cast sheet is heated for example it will shrink such that on cooling again it will be approximately 2% smaller in both length and breadth with a perceptible increase in thickness. No further shrinkage will then take place on reheating but this initial shrinkage must be taken into account when cutting the sheet into blanks prior to thermoforming.

When extruded sheet is freely heated it will exhibit rather more shrinkage in the direction of extrusion and very little across the direction of extrusion. It is difficult to give precise figures for shrinkage of extruded sheet because this will depend on the thickness and the heating time. As a general rule, 2mm sheet will shrink slightly more than 5mm sheet when freely heated, typically about 5%.

When sheets are clamped cold in a frame prior to heating the shrinkage is restrained and no allowance for shrinkage should usually be necessary.

1.2.4 Cooling

After thermoforming, Perspex® cast sheet should be kept on the mould until the temperature has reached about 60°C. Uniformity of cooling is important to prevent warpage and stress but mouldings should not be left on the mould too long otherwise they may contract tightly on to the mould and damage when lifted off.

1.2.5 Thermoforming of colours

Certain Perspex® colours can change slightly during the heating process, especially if the sheet is overheated. It is always important to ensure that the first surface is always the show face as the second surface can be slightly duller after heating. It is also important to note that as coloured sheet is stretched during thermoforming there will be an inevitable thinning of the sheet in those areas which can give rise to a reduction in opacity.

For Perspex® cast sheet colours, the show face is always that surface covered by the printed masking film.

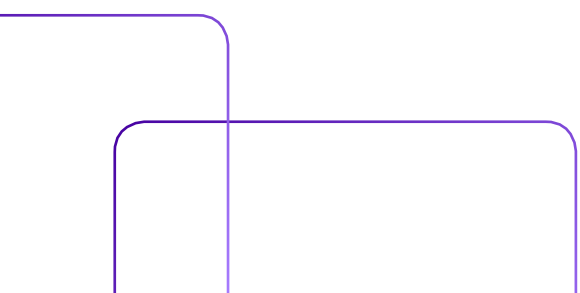
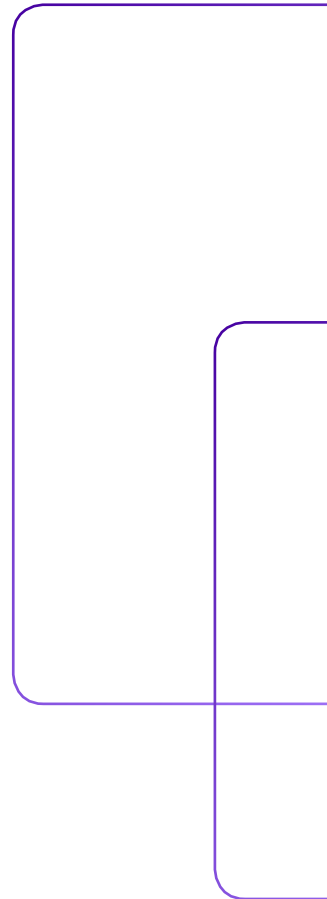

1.2.6 Methods of thermoforming

Perspex® can be thermoformed by a number of simple techniques, the most suitable of which will depend on the amount of stretch required to achieve the desired result. For blowing domes and similar shapes a blowing table will be needed fitted with toggle clamps and using steels rings to clamp the hot sheet down. Figures 7 and 8 illustrate typical basic designs.

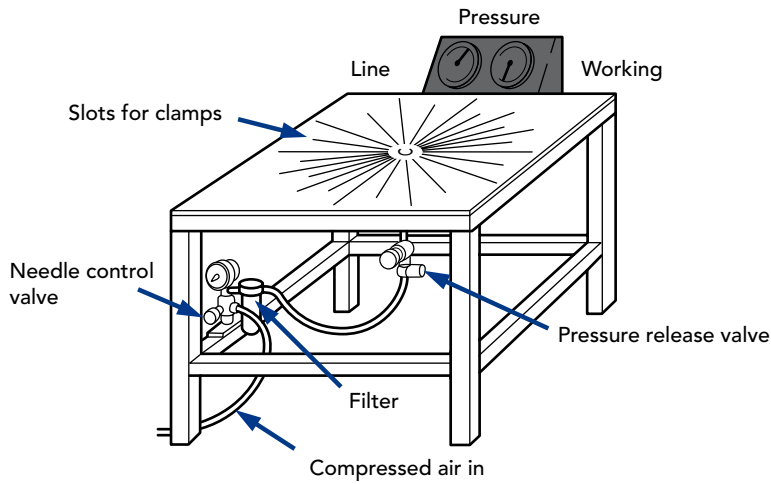

Figure 7 Typical blowing table

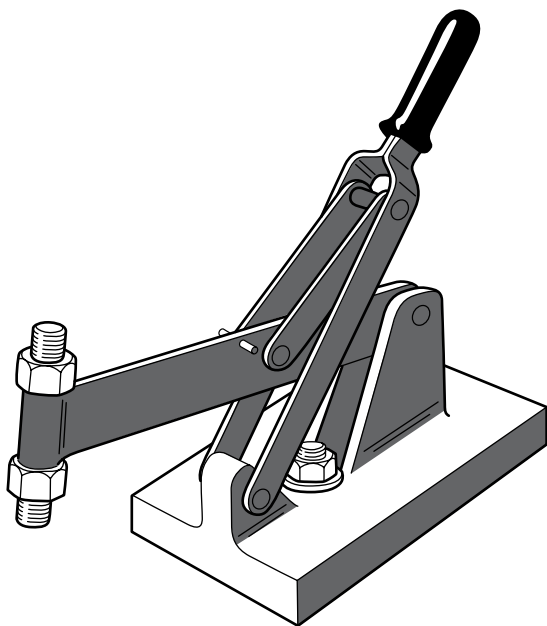
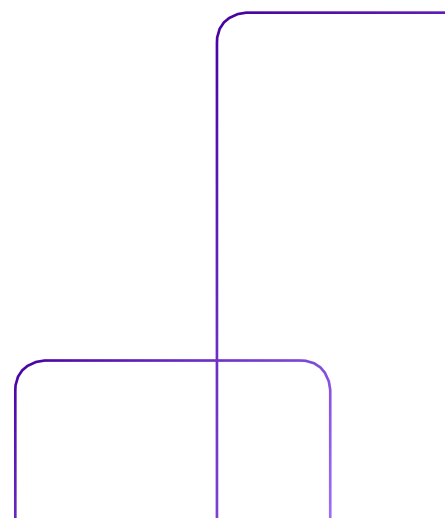
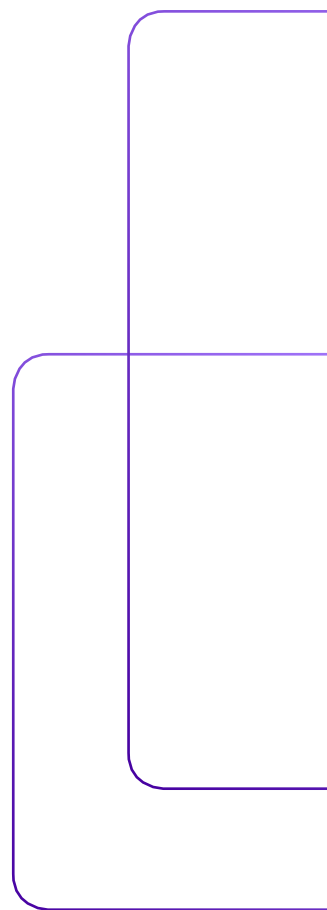

Figure 8 Toggle clamp



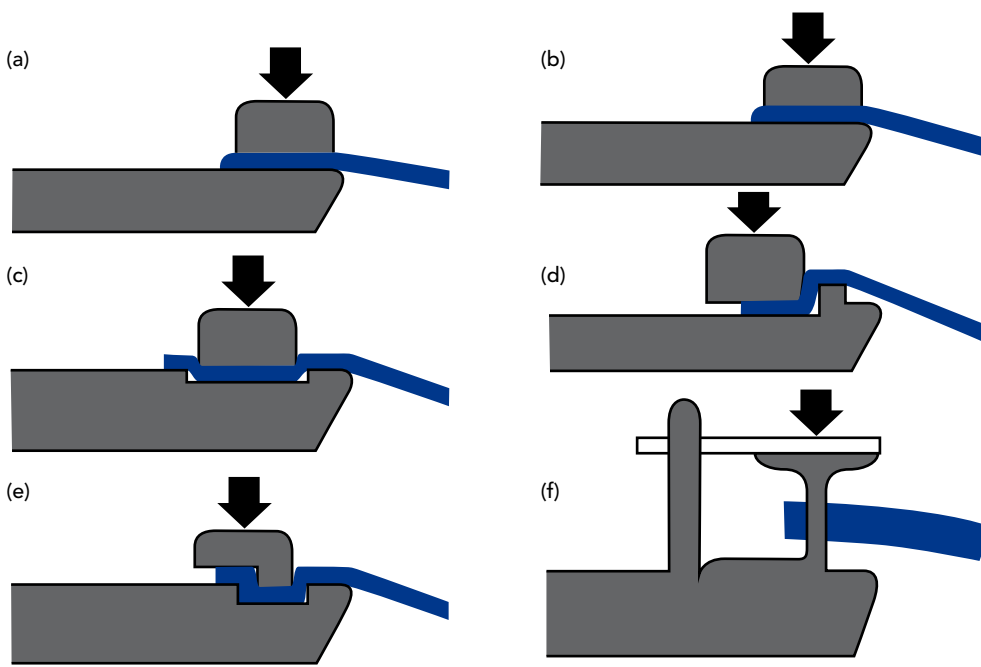

Figure 9 illustrates typical clamping designs to hold the hot sheet under the blowing ring using toggle clamps.

1.2.6.1 Single curvature thermoforming

Because there is virtually no stretching, single curvature thermoforming requires very little force. Figure 10 shows a typical mould for making motor cycle windscreens. The hot Perspex® is laid on to the mould covered with several layers of mould cloth to prevent surface marking. The sheet then takes up the shape of the curvature.

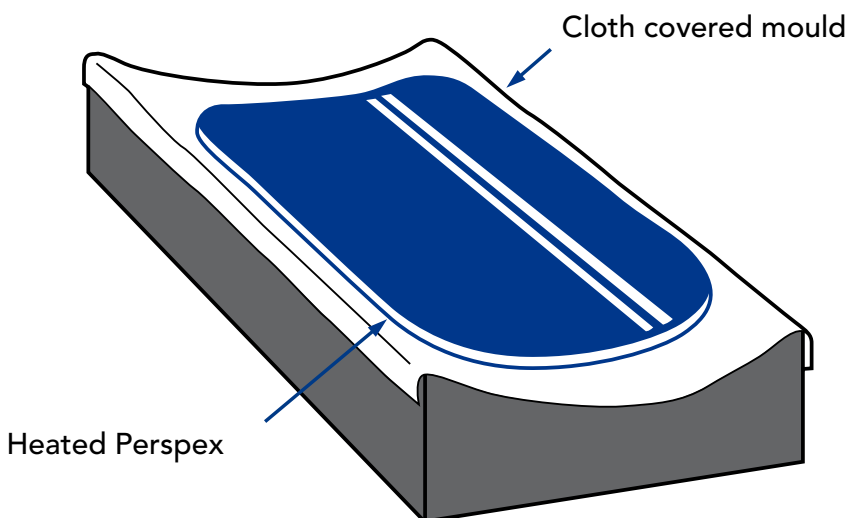

Figure 10 Single curvature thermoforming

Drape forming is another single curvature thermoforming technique. Slightly more force is applied by draping the hot sheet over a mandrel mould and holding it there with several layers of soft mould cloth until it has cooled. See Figure 11.

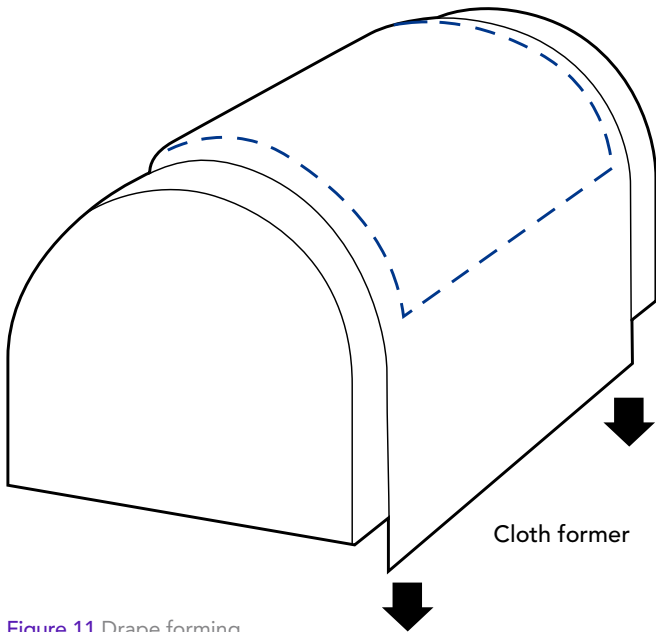

Figure 11 Drape forming

1.2.6.2 Tubes

Tubes can be made by laying the hot Perspex® sheet into a split cylindrical mould and dropping this into a jig to keep it tight. Allowance has to be made for thermal contraction and some experimentation may be required to obtain the correct blank size. Once shaped, the split line may be cemented.

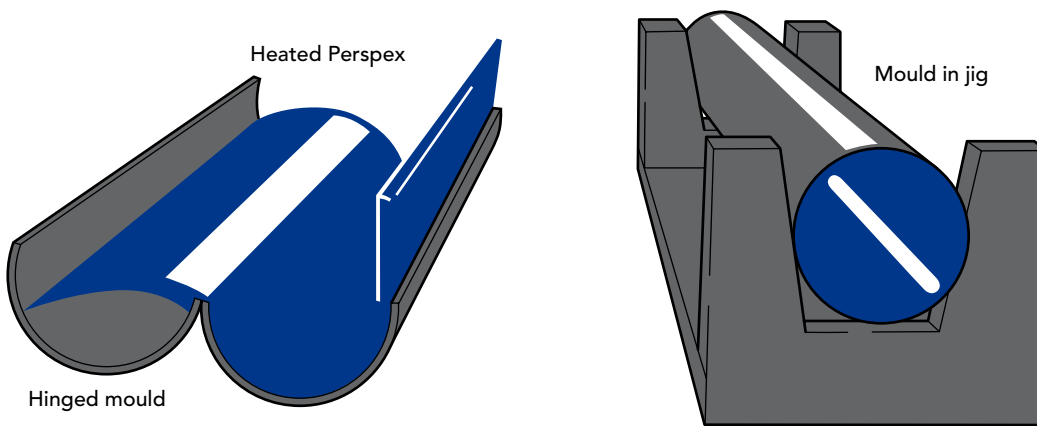

Figure 12 illustrates the method and tooling. The technique is useful for producing large diameter tubes for display models for example which cannot be conveniently made by extrusion or casting.

1.2.6.3 Local bending

Local bending - sometimes referred to as line bending - is a very important technique for producing display items, point-of-sale and many more components from Perspex®, including boxes, shelf racks, light fittings, food trays, etc.

Perspex® sheets are softened along a narrow line by a strip heater, usually a hot wire. When the shaping temperature is reached the sheet is bent and clamped or placed in a jig to cool. Suitable heaters for local bending work include nichrome wire and electrical heating tapes, depending on the radius of curvature needed and thickness of sheet used.

For sheets thicker than 5mm double sided heating is recommended and although the equipment can be built in the workshop, excellent commercial machines are readily available. Figure 18 shows a typical cooling jig for local bending.

For local bending of thick cast sheet where a sharp radius is required, it can sometimes be helpful to machine a "V" groove along the inside face to approximately half the sheet depth. This has the effect of removing material and making it easier to bend into a sharp angle but at the risk of producing a weaker edge.

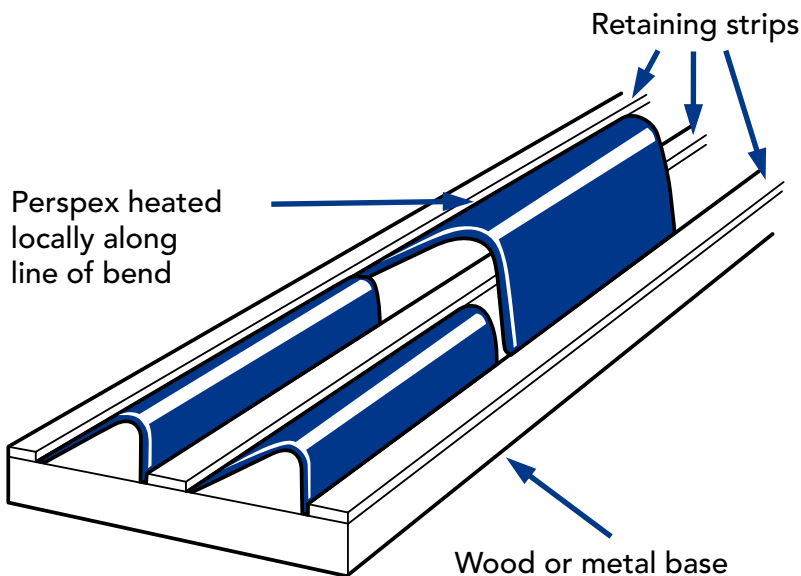

Figure 13 Cooling jig for locally bent Perspex®

For a sharp bend, the width of the heating zone should be about 4 to 6 times the thickness of the sheet. When local bending of long shallow sections, some warpage will be noticed along the line of the bend. This is always possible with local bending and is very difficult to avoid. If warpage is totally unacceptable the only alternatives are full sheet thermoforming or cementing.

To reduce warpage it is advisable to produce as near to a right angled bend as can be accepted since this will provide extra stiffness to the panel. Distortion tends to be greater the more shallow the angle of bend.

NB: Local heating of Perspex®, especially line bending, induces localised stresses in the line bend due to shrinkage along the heated section. Stress cracking can occur - especially with extruded sheet - in the presence of solvents in cements, inks or spray paints. To minimise the risk of crazing, all locally bent components should be annealed after bending.

1.2.6.4 Vacuum Forming

Vacuum forming is a well-established process for shaping articles from polymer sheet materials and many commercial computer-controlled vacuum forming machines equipped with infra-red heating platens are available for high speed production work. Perspex® extruded sheet is ideally suited to the vacuum forming process because, due to its lower melt strength, it can be drawn by the relatively low vacuum forces, has high extensibility and therefore high definition within the mould.

Perspex® cast sheet requires higher shaping forces and is therefore less suitable for the low pressure vacuum forming process - unless the shapes are quite large and simple in design such as a domestic bath.

1.2.6.5 Moulds

For long production runs and high quality mould detail cast aluminium moulds cored for water cooling are recommended. A smooth matt finish is preferred and all dust must be kept clear of mould surfaces to prevent dust marks, especially when moulding clear sheet. Mould temperatures should be maintained at between 75-85°C.

a) Pressure assisted press forming.

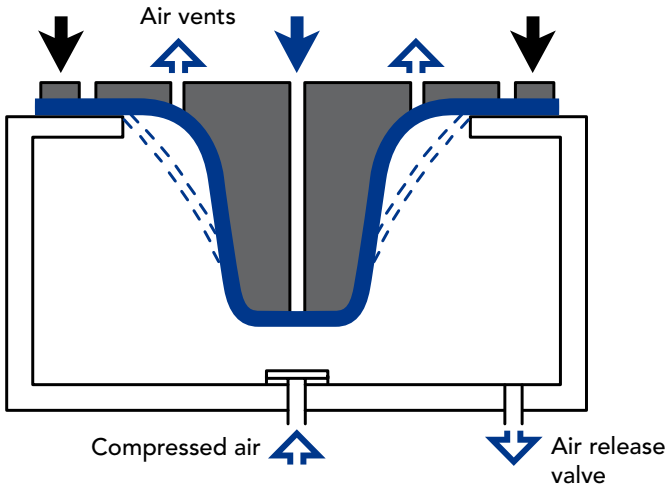

b) Vacuum assisted pressing with cold plunger.

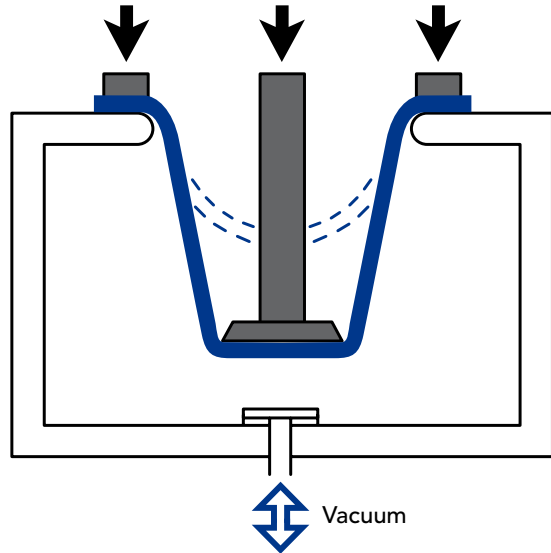

Figure 14 Press forming using air and/or vacuum

Heating

Double-sided heating is recommended for all Perspex® vacuum forming above 2mm thickness. It is difficult to give precise recommendations on heating times and conditions because these vary according to the machine design and the machine supplier may be able to give some information. Generally speaking, top heaters are typically set for a heat output of 20kW/m² and lower heaters for 8kW/m². Starting at this level the sheet should be heated carefully and examined regularly until it is ready for shaping.

Some trial and error will be needed to reach this stage but it is particularly important not to overheat the sheet and allow it to sag on to the hot lower heater since damage could occur to the machine with the possible risk of fire. The use of "levelling" is advisable by injecting air into the box cavity so supporting the hot sheet during the final heating stages.

Extruded sheets can absorb moisture which can cause blistering when vacuum forming. If moisture blisters occur when vacuum forming Perspex® XT the sheet should be dried before use, preferably with the masking film removed. At least 24 hours drying time may be required at 75-85°C.

1.3 Cementing, Fixing & Sealing

1.3.1 Cementing

All grades of Perspex® can be bonded using acrylic cements. A range of Tensol® cements and Tensol® adhesives is produced and supplied by Bostik® Ltd, to whom all enquiries should be directed.

The correct selection of adhesive is vital in order to produce bonds with good strength, durability and optical clarity.

1.3.1.1 Lamination/Face-to-Face Bonding

Two sheets of Perspex® acrylic may be laminated together using the solvent-free clear adhesive Tensol® 70 from the Bostik® range.

Tensol® 70 has excellent optical clarity and good mechanical strength.

1.3.1.2 Edge Bonding

Solvent welding is the quickest and easiest way of forming edge bonds. The best results can be easily and safely achieved when EXTRU-FIX/Tensol® 12 are applied using an EVO-PLAS® application bottle. Features of this system - which is intended for indoor applications - include good resistance to stress crazing, even on line-bent sections, and high clarity, bubble-free bonds. Filled systems such as Tensol® 12 offer slightly better gap filling properties.

For external applications, a highly durable adhesive such as Tensol® 70 is required.

When cementing Perspex® XT (extruded) items, great care must be taken when using Tensol® 12 or Tensol® 70, in order to avoid stress crazing. This is most critical on line bent joints, where EXTRU-FIX® may be more appropriate.

1.3.1.3 Bonding to other Substrates (metal, wood, glass etc.)

The easiest way to bond Perspex® to other substrates is by using a cyanocrylate adhesive, Bostik® 7452 is suggested. As well as being useful for bonding small areas of Perspex® to Perspex®, this system is also suitable for attaching fittings to Perspex®.

Where there are high mechanical strength requirements, a toughened acrylic adhesive, such as EVO-tech® TA 431, is to be preferred.

1.3.2 Fixing methods

The use of bolts and screws is not normally recommended for securing Perspex® sheet. If such methods must be used, care must be taken to ensure that adequate allowance is made for thermal expansion and contraction. Oversized holes must be drilled and screws must not be over tightened. Self-locking nuts should be used and the use of cup washers is recommended to assist in spreading loads.

1.3.3 Sealing

Joints in Perspex® and a variety of other materials can be effectively sealed with a suitable, acrylic compatible silicone sealant. In order to avoid stress-crazing, the sealant needs to be neutral cure. A low modulus type, such as Bondflex® Low Modulus Silicone Sealant will best accommodate any movement in/between the components.

The Bostik® range of adhesives, Cleaning solvents, Mirror Adhesive and Anti-static Cleaner is available from most Perspex® stockists and distributors. Alternatively please contact Bostik® directly.

Before cementing, the user should study the safety data sheets and ensure that the adhesive is suitable for the intended application.

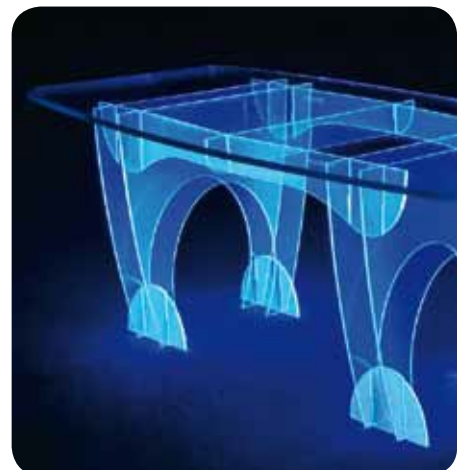

1.4 Printing, Painting & Surface Decoration

1.4.1 Screen Printing, spray-painting and hot-foil stamping

Perspex® can be readily screen printed, painted or hot-foil stamped. Paints and screen inks formulated for use on acrylic sheet must be used and it is strongly recommended that the sheet surfaces are washed before decorating to obtain maximum service life outdoors. Screen inks are available for thermoforming and it is important to ensure that any screen inks or paints applied to Perspex® have adequate UV stability.

1.4.2 Self-adhesive vinyl films

Coloured designs and letters can be applied to Perspex® to make signs using self-adhesive vinyl films. These products are usually translucent, light transmitting films. In recent years, the use of vinyl films has become extremely popular following the development of small, high speed plotting and cutting machines. Designs can be quickly scanned or drawn using CAD techniques. This method of sign making lends itself well to low cost production of short runs.

As in the case of screen printing and spray painting it is essential for users to ensure that the vinyl film products chosen are suitable for use in contact with Perspex® and are formulated for long term outdoor exposure.

1.4.3 Stress in acrylic sheet

Stress is a phenomenon which can affect many materials including acrylic sheet. It is produced by the application of force and, if excessive, can result in total mechanical failure. Long before these limits are reached with acrylic sheet the appearance of fine crazing or stress cracking can occur over time which, at best, is unsightly and at worst, can reduce the mechanical properties of the material.

Stress may be generated by thermoforming at too low a temperature, by the application of mechanical force or by the generation of heat during fabrication, e.g. machining and drilling. Crazing is induced by the release of stress, especially inherent stress, brought on by exposure to chemical solvents (environmental stress cracking), cements, screen printing ink or exposure to high energy radiation.

It is therefore important to ensure that only the minimum stress is induced in acrylic sheet when fabricating or thermoforming and that component parts are designed to prevent excessive mechanical loads being applied during service. Extruded acrylic sheet has a lower stress level tolerance than cast sheet and particular attention must be given to design parameters when using this material.

Inherent stress, (i.e. moulded-in stress) can usually be eliminated after moulding or fabrication by an annealing process. This is a gentle heat conditioning process that allows the release of stress without crazing to produce a stress-free component. Annealing should be undertaken whenever fabricated parts are to be cemented or screen printed, especially when using extruded acrylic sheet.

1.5 Annealing

The recommended annealing process for cast Perspex® is as follows:

1. Place the components in an air circulating oven at room temperature.
2. Raise the oven temperature at a rate not exceeding 18°C per hour.
3. When the annealing temperature of 90°C is reached, maintain the temperature for:
 - a) 1 hour for up to 3mm thickness
 - b) 2 hours for up to 6mm thickness
 - c) 4 hours for up to 12mm thickness
 - d) 6 hours for up to 20mm thickness
4. Cool to room temperature at a rate not greater than 12°C per hour.

For thermoformed components the annealing temperature should be reduced to within the range of 70-85°C.

It is advisable to anneal all extruded sheet components before cementing, painting or screen printing.

A rapid annealing cycle which is reliable, especially for thin sheets, is to pre-heat the oven to 80°C, anneal for one hour, then remove the parts from the oven and allow cooling to room temperature.

1.6 Normalising

Perspex® cell cast acrylic sheet contains stresses introduced during the casting process and under normal circumstances these have no effect on the behaviour of the final article. If however components are being machined to very close tolerances it is advisable to remove these casting stresses by the process called normalising. By heating Perspex® above its glass transition temperature, the stresses are relaxed giving rise to a uniform shrinkage of approximately 2%.

Normalised Perspex® is therefore said to be fully stress-relieved and fully shrunk. The normalising process consists of a closely controlled temperature and time cycle depending on the sheet thickness. The sheet to be normalised is heated to 140°C in an air circulating oven and held there until it has been heated uniformly. It is then allowed to cool down slowly to avoid the reintroduction of thermal stresses.

Cooling rate from between 105-110°C to room temperature: not greater than 4°C/hour. Minimum cooling time 21 hrs. Maximum allowable differential between material and ambient temperature at time of removal from oven is 7°C.

The treatment conditions, especially for thick sheet and block, are quite critical and Table 3 gives typical normalising cycles for cast Perspex®.

Table 3 Typical normalising cycles for cast Perspex® sheet & block

Thickness (mm)	Cycle Heating to 140°C		Holding at 140°C		Cooling to 105 -110°C		Holding at 105 -110°C	
	Hour	Min.	Hour	Min.	Hour	Min.	Hour	Min.
3		30		50		30		30
4		30	1	30		30		50
5		30	1	30		30		50
6		30	1	40		30		50
8	1	00	2	15	1	00	1	30
10	1	00	3	00	1	00	1	30
12	1	00	3	45	1	00	1	50
13	1	00	3	45	1	00	1	50
15	1	00	4	15	2	00	2	00
20	1	30	5	30	3	30	3	00
25	1	39	7	00	3	30	3	30
30	1	45	8	30	4	45	4	00
35	2	00	9	45	5	00	5	00
40	2	30	11	15	5	30	5	45
45	2	30	12	30	6	30	6	30
50	3	00	14	00	7	00	7	00
55	3	00	15	30	7	00	7	45
60	3	30	16	45	8	30	8	30

NOTES

- 1) Assuming room temperature 20°C
- 2) Take the actual sheet thickness
- 3) For sheet thicknesses significantly different to those above either calculate the appropriate cycle, or use that given for the next larger thickness



1.7 Safety

Handling and machining

Perspex® is a hard material. Sharp edges can cause cuts and chips can damage eyes. Appropriate personal protective equipment should be worn, as sharp edges can cause cuts, and chips can cause eye damage.

Thermoforming

When using presses or rams for thermoforming it is imperative that adequate safety devices are in place to prevent hands being trapped during the operation of the press. These should include guards and safety interlocks, and all safety fixtures must be maintained in good working order.

Ovens should be fitted with fail-safe thermal cut-out switches to prevent the risk of overheating.

Flammability

All Perspex® grades are combustible and if ignited will continue to burn. Little smoke is evolved when Perspex® sheet burns. Perspex® burns similar to hardwood and Perspex® cast sheet does not form molten droplets.

Users of Perspex® are recommended to consult the appropriate Perspex International MSDS which is obtainable from your supplier. Users of other materials mentioned in this publication but not produced by Perspex International are advised to obtain Health and Safety information from the suppliers.

1.8 Recycling

Perspex® acrylic sheet can be fully recycled back to its original monomer. For further information on recycling Perspex® sheet please contact your Perspex® sales office.



Part 2: Design & Applications

2.0 Perspex® Products

Perspex® Cell Cast Acrylic Sheet

Cast Perspex® is the original cell cast product first produced 80 years ago. It offers better optical properties and craze resistance than other acrylic sheet products and hence is often the choice for applications requiring critical visual performance. It is available in a very wide range of colours and thicknesses. An impact modified grade of cast sheet is also available as is a variety of textured surface products for glazing applications. For full details of the products we offer, please see our Product Range.

Perspex® CC (Continuous Cast)

Perspex® continuous cast sheet has a very narrow thickness tolerance and is easy to thermoform. It is suited to glazing and thermoforming applications requiring improved optical and chemical properties compared to extruded sheet.

Perspex® XT (Extruded Sheet)

The standard grade of extruded sheet is ideal for general glazing applications and is available in a range of clear, opal and tinted grades. Perspex® extruded IM impact modified grades are also available – see later. Please refer to our Product Range for full details of the available product range.

ShinkoLite™ MR200

ShinkoLite™ MR200 is a double sided hard-coated continuous cast acrylic sheet manufactured by Mitsubishi Rayon Company (MRC), using an in-line process that offers significant advantages over traditional hard coating methods. When allied with the technical strengths of the continuous cast acrylic sheet to which the hard coat is applied, the result is a superior product appropriate for a wide range of applications requiring excellent abrasion resistance.

2.1 Perspex® Glazing

For many years Perspex® acrylic sheet has been used as a glazing material, initially for aircraft canopies and then for a wide variety of architectural, automotive and industrial applications, which take advantage of some of the many outstanding properties of Perspex®:

Exceptional light transmission with no inherent edge colour

Clear Perspex® transmits 92% of all visible light

We offer a ten year weathering guarantee on the outdoor performance of most grades of Perspex® sheet. No significant change in visual appearance or physical performance will take place during ten years outdoors.

Low weight and safety

Perspex® is half the weight of an equivalent glass panel and is five times stronger. It is internationally recognized as a safety glazing material meeting the requirements of ANSI Z.97 and BS6262.



2.2 General Glazing

2.2.1 Compatible products

When installing Perspex® glazing panels it is essential to ensure that all ancillary products and materials used in contact with the sheet are fully compatible with acrylic. Failure to observe this may result in permanent damage to the Perspex® glazing. For example, rubber sealing strips and profiles should be made from butyl rubber or polysulphide rubber. Certain EPDM rubbers can be used as alternatives, as can compatible silicone sealants, **but in all cases it is important to seek the advice of the product supplier before use.** Plasticised PVC sealing strips should not be used under any circumstances as these are known to cause stress crazing of acrylic sheets.

2.2.2 Recommended thickness of Perspex® for Windows

The required thickness is dictated by two considerations. The first is the desired impact strength and the second is the wind loading which an external window must sustain. In most countries statutory requirements or codes of practice exist which specify wind loads for building structures and these must be followed. For example, in the United Kingdom, BS CP3 Chapter V Part 2 is the Code of Practice to be followed when designing windows or glazed structures.

Figures 15 and 16 give the recommended thicknesses of Perspex® for various wind loads.

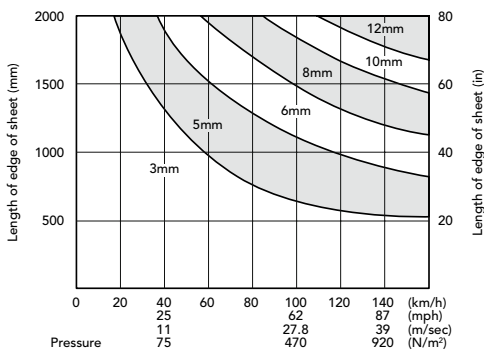

Figure 15 The recommended thicknesses of Perspex® for various wind loads when designing for square windows, with all edges fully supported

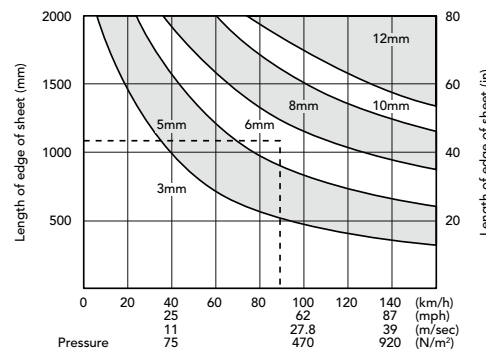

Figure 16 The recommended thicknesses of Perspex® for various wind loads when designing for rectangular windows, with all edges fully supported

NB: The figures for sheet thickness apply to areas bounded by the curves

Example of the use of Figure 16

To determine the thickness of Perspex® that must be used for a window 1100 x 1520 mm with a wind load of 90km/h (380 N/m²), determine the point of intersection between wind load line and shorter panel size (see the dotted line). The recommended thickness is 6 mm.

NB: At the recommended thickness, the sheet can deflect under full wind load and it is therefore important to use the appropriate depth of rebate, as recommended in Table 4, to ensure the sheet remains firmly fixed in the frame.

2.2.3 Installation

2.2.3.1 Mounting Details

The preferred method of mounting Perspex® glazing is between metal frames. Aluminium profiles or glazing bars are generally acceptable.

As a general rule, Perspex® should be fixed in the frames with rubber profile sections as is the normal glazing practice. If preferred, flexible mastics may be used and polysulphide sealants have been found to be suitable for this purpose. Silicone sealants can be used but, as stated earlier, it is very important to use rubber profiles or sealants which are known to be compatible with acrylic sheet.

In the event of any doubt the manufacturer’s advice should be sought first. When installing glazing in any frame system, two critical observations need to be taken into account:

1. Thermal expansion clearance
2. Rebate depth

2.2.3.2 Thermal expansion clearance

Perspex® has a high thermal expansion coefficient compared to traditional glazing materials and allowance within the frames must be made in both directions for thermal expansion and contraction. Failure to observe this rule can lead to stresses in the sheet which can cause distortions in the panel and crazing at the edges of the sheet in time.

An allowance of 5 mm per metre run length should be allowed in both dimensions during installation. This figure has been found from long experience to be sufficient for all locations and climates.

2.2.3.3 Rebate depth

It follows from the above that the rebate depth must be sufficient to allow for the expansion clearance and also the thermal contraction that can take place in winter. Rebate depth must also be sufficient to prevent the sheet from being deflected out of the frame in gale force winds.

Figure 17 shows a typical profile assembly and Table 4 the recommended rebate depth for various panel sizes, based on installation at 20° C.

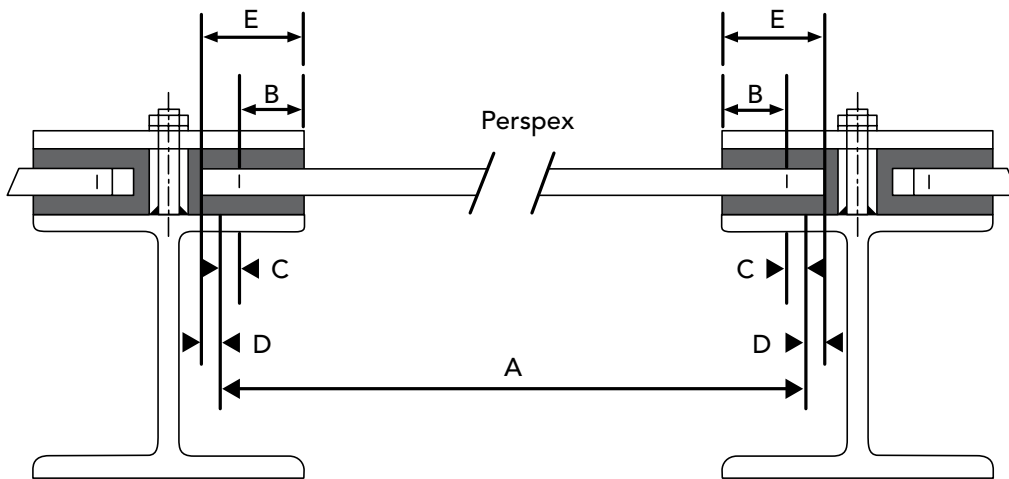

Figure 17 Mounting details for Perspex® glazing

Table 4 The recommended rebate depth for glazed Perspex® panels in frames

Nominal Panel Size (A)	Minimum Rebate Depth (B)	Contraction Allowance (C)	Expansion Allowance (D)	Total Rebate (E)
1000mm	30mm	5mm	5mm	30mm
2000mm	35mm	10mm	10mm	55mm
3000mm	40mm	15mm	15mm	70mm

2.2.4 Sound Reduction Index

Table 5 The Sound Reduction Index of Perspex® in decibels (db)

Glazing Option	Sound Reduction Index (db)
1 x 3 mm Perspex®	26
1 x 6 mm Perspex®	32
1 x 8 mm Perspex®	34
1 x 12 mm Perspex®	35

To maximise the efficiency of double glazing it is important to minimise sound leakage within the glazing profile.

2.2.5 Heat Transfer Coefficient & Thermal Conductivity

Table 6 The heat transfer coefficient (U value) of Perspex® and glass windows measured in W/m2. °C

Glazing Option	Air Gap Between Panels	Heat Loss (U Value)	
		Glass	Perspex®
3 mm single pane	-	5.6	5.2
5 mm single pane	-	5.5	4.9
3 mm double pane	3mm	4.0	3.6
3 mm double pane	12mm	3.1	2.9
3 mm double pane	20mm	2.9	2.7

Table 7 The thermal conductivity coefficient (K value) of Perspex® and glass

Unit	Glass	Perspex
Wm/m2. °C	1.15	0.189

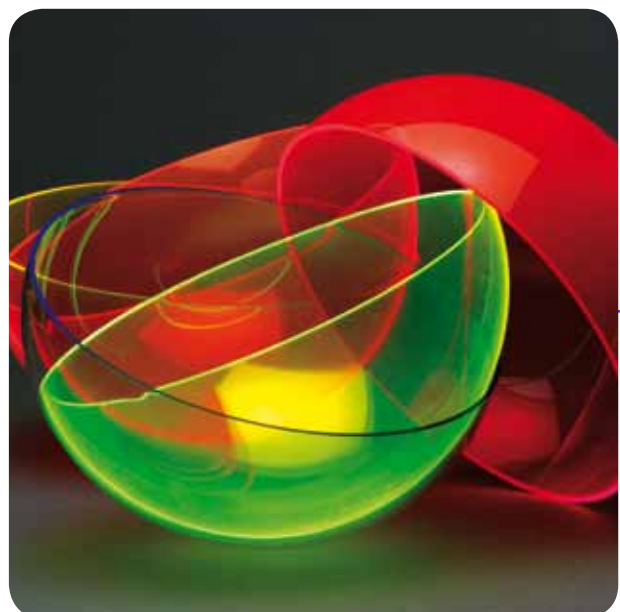

2.2.6 Perspex UV Absorbing & IR Transmitting Grades

In addition to the standard grade of Perspex®, we also offer UV absorbing and IR transmitting grades:

Perspex® Cell Cast VE and VA - absorbing UV Light Perspex® VE is available for applications where the minimum transmission of UV light is required, e.g. the glazing of museum exhibits to protect delicate artefacts. Perspex® VE absorbs 99.99% of all incident UV light below 400nm.

Perspex® VA has been developed for applications requiring extreme resistance to UV light. It is therefore the preferred grade for glazing applications in tropical regions. It is also suitable for high UV intensity street lighting applications.

VA can also be a preferred product for picture or artwork glazing applications where maximum UV protection coupled with excellent colour rendition is required.

Perspex® Cell Cast Black 962 - transmitting infra-red light

Perspex® Black 962 is a unique product which whilst appearing black to visible light gives excellent transmission in the near IR region (850nm). The product finds uses particularly in remote control and infra-red monitoring devices.

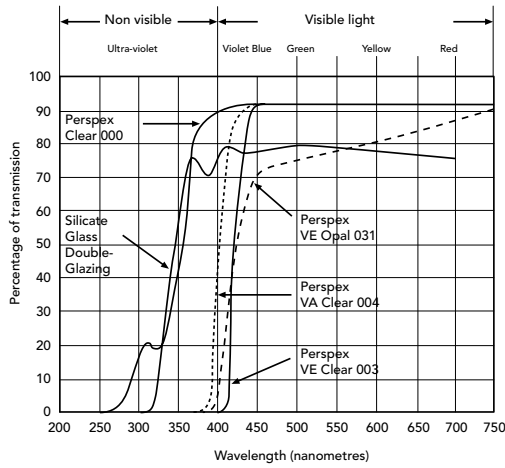

Figure 18 Spectral transmittance of 3 mm Perspex® cast sheet grades compared with silicate glass

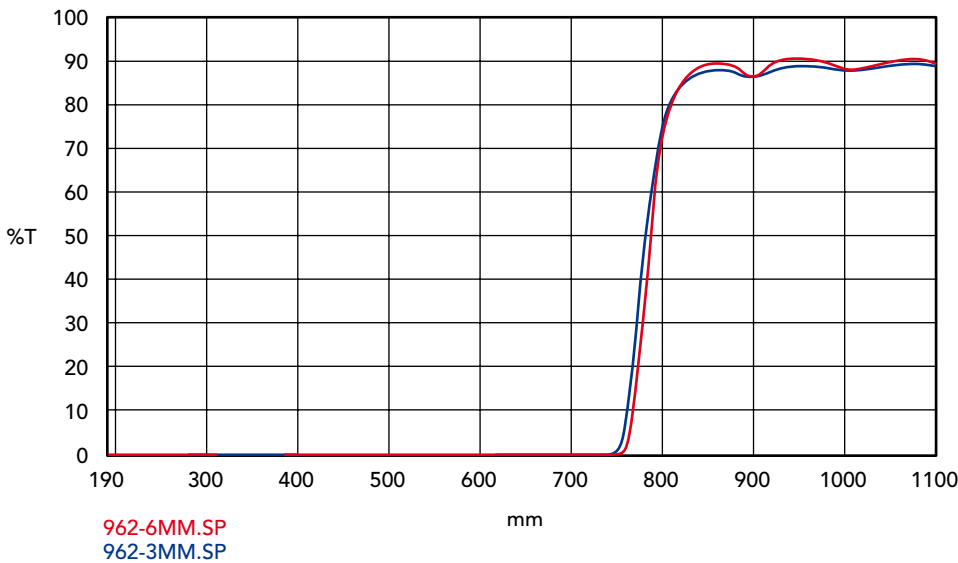

Figure 19 Spectral transmittance of Perspex® 962

2.3 Glazing Applications

2.3.1 Roofing

NB: It is the installer's responsibility to ensure that the design and construction of any Perspex® glazing structure complies with the statutory requirements of all local building codes or official building control standards.

Perspex® acrylic has been extensively used as a roofing product in applications such as moulded dome lights and continuous roof lights or barrel vaults. (Typical sheet thickness recommendations are given below).

The below figures were originally derived from stress/strain studies. From experience gained over 20 years it is known that if the minimum cold-bend radius is reduced further there is a greater risk of sheet crazing in service.

Table 8 The minimum cold-bend radius for Perspex® barrel vaults in temperate climates

Sheet Thickness (mm)	3	4	5	6
Perspex® Cast	600	800	1000	1200
Perspex® Extruded	900	1200	1500	1800

Table 9 The recommended thickness of cast and extruded Perspex® for barrel vaults where the barrel height is 1/2 span dimension

Barrel Span (mm)	Sheet Width	
	1000mm	2000mm
800	3mm	4mm
1100	4mm	5mm
1400	5mm	5mm
1700	6mm	6mm
2000	6mm	8mm

Table 10 The recommended thickness of cast and extruded Perspex® for barrel vaults where the barrel height is 1/4 span dimension

Barrel Span (mm)	Sheet Width	
	1000mm	2000mm
800	4mm	5mm
1100	4mm	5mm
1400	5mm	6mm
1700	6mm	8mm
2000	6mm	8mm

Table 11 The recommended thickness of cast and extruded Perspex® for barrel vaults where the barrel height is 1/8 span dimension

Barrel Span (mm)	Sheet Width	
	1000mm	2000mm
800	4mm	6mm
1100	5mm	6mm
1400	6mm	8mm
1700	6mm	8mm
2000	8mm	10mm

NB: 1. All the above calculations have been based on an assumed wind load of 1000 N/m². 2. When using impact modified grades the above thicknesses should be increased to the next size.

Table 12 The recommended thickness of cast and extruded Perspex® for flat roofs

Roof Span (mm)	Sheet Width		
	800	1000	1200
800	5mm	6mm	6mm
1400	6mm	8mm	8mm
2000	6mm	8mm	10mm

The values for Table 10 assume a snow load of 750 N/m².

2.3.2 Balcony Guards

Perspex® has been used for balcony guard in-fill panels across Europe for over 20 years. Typically, 6mm and 8mm sheets are used to ensure rigidity and impact strength. Following testing, approval has been gained to ANSI Z.97, BS 6206 and NFP 01-013.

The exceptional weathering performance of Perspex® ensures that no significant loss of mechanical properties takes place over a number of years.

We recommend that infill panels made from Perspex® should be supported on all 4 edges to provide sufficient panel rigidity at a minimum sheet thickness. In order to reduce the possibility of the infill panel being sprung from its frame, the rebate depth should be at least 20mm. If only 2 edge support is possible, then the thickness of the Perspex® sheet should be increased because of the lower flexural strength of the fixing system. Also minimum rebate depths should be increased to 35mm to prevent "spring out" occurring.

Bolt fixing at the edge of a Perspex® sheet should NOT be used as the primary support method without the use of load spreading devices, because of problems associated with stress build-up and crazing in service.

Similarly the panel must be fitted on the inside of a support post to ensure that any impact loads bear against metal supports and not the fixing bolts. All bolt holes must be drilled oversize and contain Neoprene washers. Also a good quality Neoprene gasket should be used between Perspex® and any metal.

2.3.3 Security Glazing

Clear Perspex® of the correct thickness can be used as security glazing for protection against projectiles from hand guns and other firearms.

The superb clarity of Perspex® makes it particularly attractive for the protection of prestigious offices, banks and other public buildings. Perspex® may also be used as self-supporting structures, free from metal framing, for added design appeal.

Perspex® can be laminated with other glazing materials, e.g. glass and polycarbonate, to produce high specification bullet resistant glazing.

2.3.4 Boat Glazing

Outstanding weathering performance and its resistance to marine environments are the reasons why Perspex® is used throughout the world as a high specification boat glazing product.

A wide range of attractive tints are available in various thicknesses to provide style, safety and comfort.



2.3.5 Vehicle Glazing

Since its introduction as a tough and durable product for aircraft glazing, Perspex® has found many new uses within vehicle glazing not only because of the many attributes listed previously but also because of its good chemical resistance to motor oils and fuels.

Its ease of fabrication permits Perspex® to be manufactured into articles not possible with glass. Perspex may easily be refurbished by polishing.

Typical automotive glazing products made from Perspex® include:

- Caravan windows
- Motor cycle windshields
- Glider and helicopter glazing
- Commercial aircraft interior window panels
- Marine glazing
- Submarine periscopes
- Vehicle Registration Plates
- Car wind deflectors
- Truck visors
- Car wind deflectors
- Vehicle Registration Plates

Thermoformed acrylic sheet is now almost exclusively used as the glazing for touring caravan windows where all the requirements for light weight, safety, good weathering properties and ease of fabrication to produce double gazed units are met. In addition, certain Perspex® grades and thicknesses are accredited to the German Transport Regulations (ABG) as approved materials for roof lights, side and rear windows for vehicles and caravans.

2.3.6 Flooring

Many entertainment buildings (e.g. dance halls and restaurants either interior or exterior) use the light transmitting property of Perspex® to provide design features.

Perspex® sheets and blocks are used because of their resistance to breakage, weathering and scratching.

The prime requirement of these floors is that they must feel rigid to walk across. Care should be taken to ensure the floor design meets all local building codes. The Table below gives recommendations for Perspex® sheet thickness against panel size assuming a loading requirement of 5000 N/m².

Table 13 Guideline thicknesses of Perspex® required for different areas:

Panel Size (mm x mm)	Minimum Sheet Thickness	To Restrict Deflection to 1/4 Sheet Thickness
300 x 300	8mm	12mm
750 x 750	15mm	20mm
1000 x 1000	20mm	30mm
2000 x 1000	25mm	30mm
1500 x 1500	30mm	35mm

The surface hardness of Perspex® is usually acceptable for floors and if required the surface gloss can be refurbished by polishing.

The Perspex® floor should be protected against damage arising from contact with a metal or wooden support structure. This can be achieved by the use of acrylic compatible glazing rubbers.

2.4 Lighting

Traditionally a wide range of gloss opal colours have been used in lighting applications, however the increasing popularity of LEDs has not only led to the emergence of thinner light boxes with improved energy consumption, but also to the use of grades of Perspex® providing better diffusion. Perspex Crystal Clear Frost (S2 000) is an ideal material where maximum light output is required and Perspex® Frost S2 1T96 is the optimal material where maximum diffusion is required. All of our Frost products have the added advantage of retaining the Frosted surface even after thermoforming.

2.5 Visual communications

Over the years Perspex® has established itself an enviable reputation as one of the most creative, flexible and eye-catching products in the market for corporate imaging, signage, Point-of-Sale displays and shop fitting. From international companies to smaller specialist outlets, Perspex® is used to create signs and displays that are long-lasting, attractive and cost effective.

Perspex® for Signage

- **Perspex® Colours and Opals (including Perspex® Spectrum LED):** available in thicknesses from 3mm to 30mm to allow production of signs and letters.
- **Perspex® Secret Sign:** a single sided matt product which appears black when non-illuminated, and either white, red, green or blue when the material is back-lit.
- **Perspex® Duo:** a dual layer of black and either Gold or Silver which can be engraved to allow the base colour through.
- **Perspex® S-Lux, D-Lux and Prismex:** our patented edge-lit lighting technology for communications and lighting applications.

Perspex® for Displays

- **Surface Effects:** Perspex® Frost, Impressions, Satin
- **Edge Effects:** Perspex® Fluorescent, Vario, Metropolitan and Glass-Look
- **Enhanced Chemical Resistance:** Perspex® Forte
- Perspex® Vision for rear-projection

Colour Matching

Our in-house laboratory can match almost any colour, as well as guaranteeing batch-to-batch colour consistency.

The following sections offer guidance on constructing signs made from Perspex®.

2.5.1 Illumination

Lighting an internally illuminated sign made from Perspex® acrylic sheet requires careful consideration to achieve maximum visual impact. With the wide range of available colours of Perspex® sheet and the many different types of light sources, it is not possible to present a simple set of rules which assures the most effective results for every individual sign design.

For most types of sign however the method of lighting is predictable and general guidelines are given in this booklet which will enable the designer to create aesthetic appeal combined with a suitable level of luminance. Where a sign is of unusual design it may be necessary to construct an experimental prototype in order to establish the most effective means of illumination.

For details of light sources, electrical gear and additional technical support on lighting design the lamp manufacturer should be consulted.

2.5.2 Luminance

The term luminance is used to describe the measured brightness of a point on a surface, when viewed in a given direction. Of the various photometric concepts, luminance is the one which is most relevant to the design of an illuminated sign. In the following paragraphs the concept of luminance and its applications are described in practical terms.

For the purpose of considering glare in relation to luminance it is best to consider luminance as "brightness" in the simple sense. The degree of glare caused by a sign depends on many other factors as well as its brightness. These include its size, colour, its position relative to the direction from which it is seen, the brightness of its surroundings and the age and maintenance of the sign. A sign mounted in a well-lit city street will appear less bright than the same sign seen in the darkness of the countryside. The sign must therefore be bright enough to command attention but not so bright as to cause annoyance to local residents or distract the attention of motorists.

To decide on the very complex problem of how bright a sign should be in any particular location reference should be made to a report entitled Technical Report No.5, "Brightness of Illuminated Advertisements", copies of which can be obtained from the Institution of Lighting Engineers (www.theilp.org.uk).

The luminance of any internally illuminated sign or fascia is determined by five factors:-

1. **Light source** - their number, type, light output, colour and position in the sign case.
2. **Materials** - the light transmission, reflection, absorption and diffusion factors of the Perspex® grade and thickness used.
3. **The Sign Case** - its dimension, particularly its depth and the reflection factor of the paint or other finish used on the inside of the case.
4. **Light Absorption** - the effect of absorption of light by the lamps and electrical equipment within the case.
5. **Maintenance** - the reduction in the light output of the lamps with increasing age and the influence of dust inside the case.

2.5.3 Light Transmission

Planning authorities often apply a simple formula to assess the brightness of a sign to ensure it conforms to the agreed limits and this requires the light transmittance value of the sign making material. The light transmission values of all Opal/White grades and most of the popular Perspex® sign colours are listed in section 3.1.

2.5.4 Diffusion Factor

When designing signs made from Perspex® sheet, consideration must be given to the diffusion factor of the chosen colour. A good diffuser when illuminated will scatter direct or transmitted light uniformly in all directions.

If a material has a diffusion factor of between 0.82 and 0.89 it can be considered to have maximum degree of diffusion. All Opal/White Perspex® sheet grades have excellent diffusion except Opal/White 030 which is designed to give high light transmission with only moderate diffusion. Most translucent Perspex® colours have diffusion factors in excess of 0.80 and can be considered to be good diffusers.

2.5.5 Light Source Spacing ratio

Uniform luminance of a sign made from Perspex® sheet is dependent on the diffusion factor of the Perspex® grade and the spacing of the light source, whether this be LEDs or lamps. Generally if the diffusion factor is over 0.80, a spacing ratio of 1 to 1.5 should prove satisfactory. This ratio is calculated as follows:

$$\text{Light source spacing ratio} = \frac{\text{Distance between light source centres}}{\text{Distance from light source centre to Perspex® sheet}}$$

If a number of different colours are used in one sign then no fixed rule can be applied to obtain the level and uniformity of luminance required and a prototype should be constructed to confirm the desired effect.

A prototype sign will also ensure that the correct complementary colour balance will be achieved between the different illuminated colours without any unexpected and unwanted visual colour distortions.

2.6 Factors Affecting Perceived Colour

Perspex® offers the sign maker endless opportunities with colour – from the vast array of tints and hues available, to precise colour matching, batch-to-batch consistency and stringent manufacturing controls. There are however several factors which do affect how the colour of the sign is perceived.

2.6.1 Thickness Tolerance

Cast acrylic sheet has a manufacturing thickness tolerance, which can reveal some variation in colour by transmitted light at opposite ends of the tolerance. This effect, inherent in the cell-casting manufacturing process, can therefore reveal slight changes in hue between certain dark colours such as greens and blues even though the thickness difference may only be fractions of a millimetre. Such slight differences in transmitted colour are most noticeable when two fascia panels are cut from different sheets and butted up together.

It is therefore strongly recommended that when making fascia signs, the cut panels are colour balanced on a full sized light box to ensure uniformity of illuminated colour. If this is not possible, thickness measurements should be taken at the butt edges and the panels aligned to give as near uniform thickness as possible across the butt joints to ensure colour uniformity before any fret cutting or cementing.

2.6.2 Surface Finish

When using Perspex® Frost, Satin or Impressions reflected colours will be slightly lighter as a result of the light scattering effect of the textured surface.

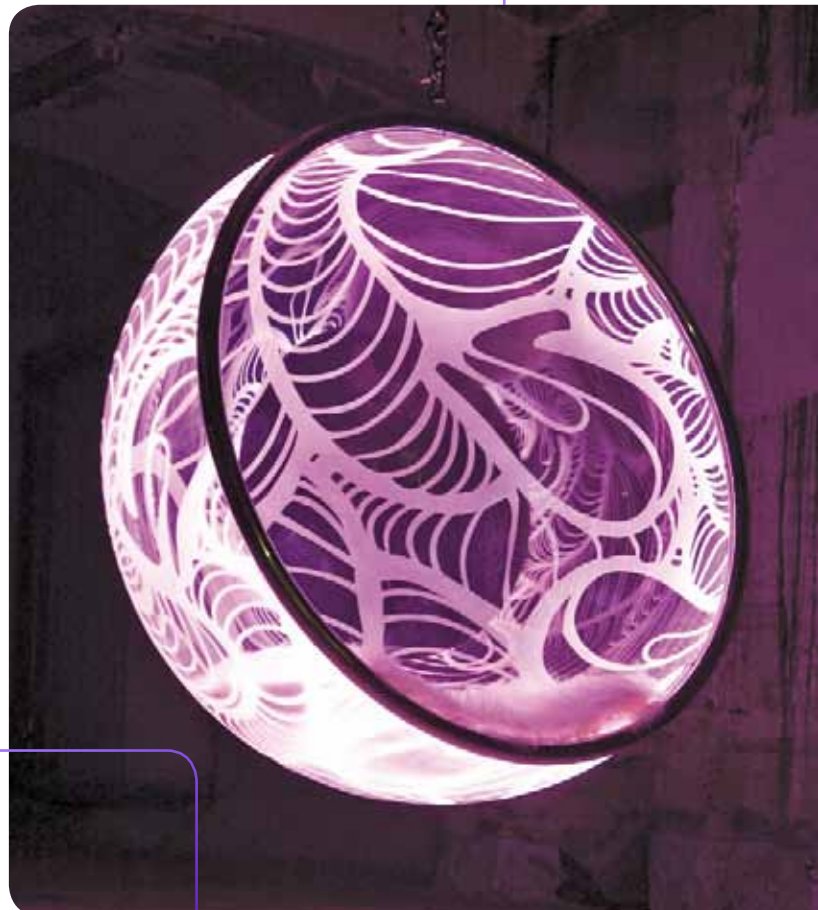
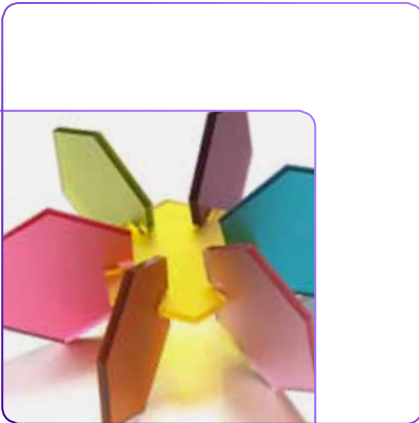

Part 3: Technical & Performance Properties

3.0 Weathering

Most grades of Perspex® acrylic sheet have outstanding resistance to outdoor weathering and can be considered amongst the best of all plastics materials. Under normal exposure conditions, correctly fabricated self-coloured signs made from Perspex® will not lose mechanical strength over a typical design life of 10 years exposure outdoors in Europe. Perspex International offers a 10 year guarantee on the mechanical performance of its standard Perspex® acrylic sheets, and copies of this document may be obtained from www.perspex.com.

During long-term exposure outdoors, especially in tropical climates, all painted surfaces, self-coloured materials and even natural materials such as stone can be expected to show some colour change with time.

In terms of the light transmission value for clear Perspex® (92%), this will not fall below 85%.

The 10 year guarantee therefore applies to that period of exposure under normal conditions during which any colour change which may occur will remain unnoticed by the casual observer from street level.

It is important to note that new panels of Perspex® installed alongside older panels of the same colour which have been exposed for some time will almost certainly display a difference in colour. This is quite normal for most coloured surfaces and cannot be avoided.

3.1 Light Transmission Properties Of Coloured Sheet

Perspex® sheet is produced to the highest quality standards which ensure colour consistency from batch to batch and sheet to sheet. Since the colour extends throughout the thickness of the sheet, scuff and scratch marks have little effect on the appearance of illuminated colours.

Most coloured Perspex® sheet is produced so that the light transmission decreases with increasing thickness. However, for those applications where this effect would not be appropriate, i.e. where different sheet thicknesses of a colour may be needed on the same sign, Constant Transmission (CT) colours are available giving the same colour transmission irrespective of sheet thickness. CT Colours are identified by the letter "T" in the colour reference number, e.g. Opal/White 1T02, Red 4T17, etc.

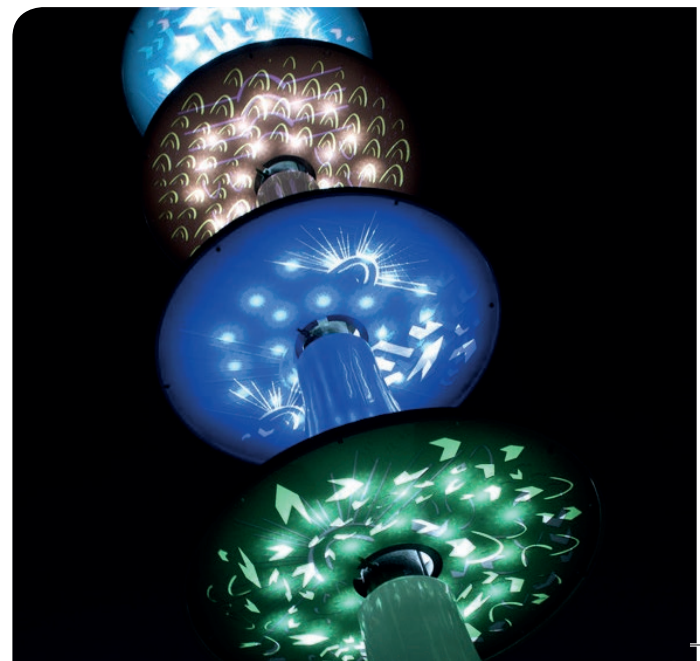

3.1.1 Light Transmission Values of 3mm Perspex® Colours

3.1.1.1 Perspex® Opals (including Perspex® Spectrum LED)

Table 14

Perspex® Grade	% Light Transmission (380 – 790 nm)
028	25%
030	67%
040	46%
050	36%
069	9%
1212	0%
1T04	30%
1T21	4%
1T67	21%
1T77	35%
1TL1	37%
1TL2	51%

3.1.1.2 Perspex® Solid and Translucent Colours (including Spectrum LED)

Table 15

Perspex® Grade	% Light Transmission (380 – 790 nm)
Cream 128	16%
Cream 133	29%
Yellow 229	19%
Yellow 260	19%
Yellow 261	29%
Yellow 2252	21%
Yellow 2TL1	22%
Yellow 2TL2	25%
Orange 363	4%
Orange 3TL1	18%
Red 431	3%
Red 433	2%
Red 440	3%
Red 4403	8%
Red 4415	6%
Red 4494	<1%
Red 4TL1	18%
Red 4TL2	14%
Red 4TL3	15%
Green 650	3%
Green 692	21%
Green 6TL1	8%
Green 6TL2	6%
Blue 727	5%
Blue 743	4%
Blue 744	<1%
Blue 750	2%
Blue 751	2%
Blue 7033	8%
Blue 7TL1	12%
Violet 886	4%
Grey 9981	8%
Black 962 (Infra-Red transmitting)	0%
Black 9T30	0%



3.1.1.3 Perspex® Transparent Colours and Tints

Table 16

Perspex® Grade	% Light Transmission (380 – 790 nm)
Amber 300	38%
Red 4401	8%
Brown 504	53%
Green 6600	14%
Green 6T21	90%
Blue 7703	8%
Blue 7704	83%

3.1.1.4 Perspex® Neutrals for glazing

Table 17

Perspex® Grade	% Light Transmission (380 – 790 nm)
Neutral Grey 901	61%
Neutral Grey 9T04	31%
Neutral Brown 9T13	54%
Neutral Grey 9T20	36%
Neutral Grey 9T21	41%
Neutral Grey 9T23	14%
Neutral Grey 9T38	36%
Neutral Grey 9T45	73%
Neutral Grey 9T56	46%
Neutral Grey 9H03	14%
Neutral Grey 9H04	35%
Neutral Grey 9T9A	42%

NB: 1. Light transmission measurements have been measured on apparatus conforming to ASTM D 1003, Illuminant C. (Values to Illuminant D65 are virtually identical in most instances.) 2. All figures quoted are the results of tests on typical samples and do not constitute a specification. 3. The above figures are for typical standard colours and are only a small representation of the Perspex® colour range. For details of other colours, or the procedure for ordering special colours, please contact your nearest Perspex® sales office.

3.2 Food Contact

Perspex Cast Acrylic sheet is capable of complying to current EU and American (FDA) food contact regulations. Please note that food contact compliance testing should be carried out on finished articles and not flat sheet samples. For further information please contact your Perspex® sales office.

3.3 Technical Data

3.3.1 Physical and mechanical properties

Table 18 Shows the typical physical and mechanical properties of Perspex® cell cast acrylic sheet.

Property	Test Method	Units	Values
General Properties			
Density	ISO 1183	g cm ⁻³	1.19
Rockwell Hardness	ISO 2039-2	M scale	102
Water Absorption	ISO 62	%	0.2
Flammability	ISO 11925-2	-	E
Optical Properties			
Light Transmission	ASTM D1003	% (3 mm)	> 92
Refractive Index	ISO 489 A		1.49
Thermal Properties			
Vicat Softening Point	ISO 306 A	°C	> 110
Coefficient of Thermal Expansion - Linear	ASTM D696	x 10 ⁻⁵ . K ⁻¹	7.7
Maximum Working Temperature		°C	80 - 85
Specific Heat	ASTM C351	cal/g °C	0.35
Thermal Conductivity Coefficient (K Value)		W m m ⁻² °C	0.189
Heat Transfer Coefficient (U Value)		W m ⁻² °C	
- 3 mm single pane			5.2
- 5 mm single pane			4.9
Mechanical Properties			
Tensile strength (5mm/min)	ISO 527	MPa	75
Elongation at Break (5mm/min)	ISO 527	%	4
Flexural Strength (2mm/min)	ISO 178	MPa	116
Flexural Modulus (2mm/min)	ISO 178	MPa	3210
Impact Strength – Charpy (unnotched)	ISO 179	kJ m ⁻²	12
Poisson's Ratio			0.38

3.3.2 Reaction to Fire

Perspex® is a combustible material and if ignited will continue to burn. Perspex® cast acrylic sheet has a combustion rate similar to hard woods but unlike many other plastic materials, in the event of a fire, Perspex® produces no hydrogen cyanide or halogen-based toxic gases and very little smoke.

Perspex® extruded sheet has a rate of combustion similar to cast sheet but will eventually produce molten droplets which will continue to burn. For full details of the behaviour of Perspex® grades to many international fire tests see table 19.

Table 19 Fire test performance of Perspex® to the more important international fire tests

Country	Product Type	Test	Result/Class
Europe	Cast & Extruded	ISO 11925-2	E
France	Cast	NFP 92-307	M4
	Extruded	NFP 92-307	M4
Germany	Cast	DIN 4102	B2
	Extruded	DIN 4102	B2
Holland	Cast	NEN 6005	Class 3 surface spread of flame
	Extruded	NEN 6006	Class 4 contribution to flashover
United Kingdom	Cast	BS 476:Pt 7	Class 4 under 3 mm
	Cast	BS 476:Pt 7	Class 3 for 3 mm and above
	Extruded	BS 476:Pt7	Class 4 all thicknesses
United States	Cast	UL 94	HB
	Extruded	UL 94	HB

Perspex® cast acrylic sheet burns at a rate similar to that of hard woods but with low smoke evolution. Encapsulating the edges of all Perspex® sheets into metal glazing profiles greatly reduces the ease of ignition.

3.3.3 Chemical Resistance

Perspex® has very good resistance to attack by water, alkalis, aqueous inorganic salt solutions and most common dilute acids. It is difficult to generalise about the effects of organic materials on Perspex®, some liquids have no effect at all, some cause swelling, crazing or weakening and some dissolve it completely.

Table 20 gives an indication of the chemical resistance of Perspex® cast clear as judged by the visual appearance of samples of dimensions approximately 100 x 12 x 6 mm immersed in typical solutions or liquids at 20°C.

Table 20 The chemical resistance of Perspex® cast clear sheet at 20°C

The following symbols have been used in the table:-

S = Satisfactory (no apparent effect apart from possible staining)

A = Some attack evident (swelling or slight crazing)

U = Unsatisfactory (the sample has dissolved, swollen, decomposed, etc.).

Chemical	Concentration	Resistance	Exposure Time	Notes
Acetic acid	10%	S	5 years	
	100%	U	1 day	Badly swollen
	Glacial	U	3 days	Dissolved
Acetone	100%	U	1 day	Dissolved
Alcohols, n-butyl		U	1 year	Crazing and disintegration
	Ethyl	10%	A	Slight attack
		50%	A	Slight attack
	100%	U	1 year	Slight swelling and softening
Isopropyl	10%	A	1 year	Crazing
	50%	A	1 year	Crazing
	100%	A	1 year	Attacked
Methyl	10%	A	1 year	Slight attack
	50%	A	168 days	Swollen
	100%	U	168 days	Swollen: weight increase
Ammonia	0.880 sol.	S	1 year	
Amyl acetate		U	28 days	Dissolved
Aniline		U	7 days	Dissolved
Aviation fuel	100-octane	A	168 days	Slight crazing
Benzaldehyde		U	7 days	Dissolved
Benzene		U	10 days	Dissolved
Calcium chloride	Saturated sol.	S	3 days	Slight attack
Carbon tetrachloride		U	84 days	Dissolving
Chloroform		U	1 day	Dissolved
Chlorine	2% in water	A	5 years	Surface crazing and attack
Chromic acid	10%	S	5 years	Stained
	Saturated sol.	U	1 year	Dissolving
Citric acid	Saturated sol.	S	5 years	
Dibutyl phthalate		A	2 years	Surface crazed
Diocetyl phthalage		A	2 years	Slight attack
Dibutyl sebacate		A	2 years	Slight attack
Diethyl ether		U	168 days	Swollen & Soft
Ethylene glycol		S	5 years	
Ethylene dichloride		U	1 day	Dissolved
Ethyl acetate		U	3 days	Dissolved
Epichlorhydrin		U	1 day	Dissolved
Formaldehyde	40%	S	5 years	
Formic acid	10%	S	5 years	
	90%	U	7 days	

Table 20 (Continued) The chemical resistance of Perspex® cast clear sheet at 20°C

Chemical	Concentration	Resistance	Exposure Time	Notes
Glycerol (glycerine)		S	5 years	
Hexane		S	168 days	Slight crazing
Hydrochloric acid	10%	S	168 days	Slight crazing
	Conc.	S	168 days	Slight crazing
Hydrocyanic acid		U	1 day	Dissolved
Hydrofluoric acid	Conc.	U	1 day	Swollen & Soft
Hydrogen peroxide	10% vol.	S	1 year	
	90%	U		
Mercury		S	2 years	
Methylene chloride (dichloromethane)		U	1 day	Dissolved
Methyl salicylate		U	7 days	Dissolved
Nitric acid	10%	S	1 year	
	Conc.	U	1 day	Swollen
Oils - transformer		S	5 years	Staining
- diesel		S	1 year	Hazing
- olive		S	5 years	Slight crazing
- paraffin (medicinal)		S	5 years	
- silicones		A	1 year	Swollen
Oxalic acid	Saturated sol.	S	5 years	Severe crazing
Perchloroethylene		U	5 years	Severe crazing
Phenol	Saturated sol.	U	7 days	Dissolved
Phosphoric acid	10%	S	5 years	
	Conc.	U	7 days	Severe crazing
Potassium dichromate	10%	S	5 years	Slight staining
Potassium hydrozide	Saturated sol.	S	168 days	
Potassium permanganate	N/10 sol.	S	5 years	Severe staining
Sodium carbonate	Saturated sol.	S	5 years	
Sodium chlorate	Saturated sol.	S	5 years	
Sodium hydroxide	Saturated sol.	S	5 years	
Sodium hypochlorite	10% chlorine sol.	S	5 years	
Sulphuric acid	10%	S	5 years	
	30%	S	1 year	Slight edge attack
	Conc.	U	1 day	Swollen
Tartaric acid	Saturated sol.	S	5 years	
Toluene		U	7 days	Dissolved
Trichloroethane		U	1 day	Dissolved
Trichlorethylene		U	1 day	Dissolved
Tricresyl phosphate		U	2 years	Attacked/crazed
Water		S	5 years	
White Spirit		S	5 years	Slight crazing
Xylene		U	7 days	Dissolved

NOTE:

Chemical resistance tests are difficult to interpret accurately because plastics materials generally may be attacked in several ways. The table must therefore be used with discretion and should be supplemented by component tests under actual service conditions.





Perspex International Ltd
Orchard Mill
Duckworth Street
Darwen
BB3 1AT
United Kingdom

T: +44 1254 874000
F: +44 1254 874098

info@perspex.com
www.perspex.com

For more details on any
of the products featured
in this brochure, please
contact our sales team on
+44 1254 874120

Potential.Performance.Perspex®



PERSPEX® is a registered trademark of
Perspex International, a member of
3A Composites. © Perspex International Ltd., 2020